



A4 SYSTEM

SERVICE MANUAL



CREDITS/COPYRIGHT

©2001 Best Lock Corporation dba Best Access Systems. All rights reserved. Printed in the United States of America.

Information in this document is subject to change without notice and does not represent a commitment on the part of Best Access Systems. The software described in this document are furnished under a license agreement or nondisclosure agreement.

This publication is intended to be an accurate description and set of instructions pertaining to its subject matter. However, as with any publication of this complexity, errors or omissions are possible. Please call your BEST distributor or Best Access Systems at (317) 849-2250 if you see any errors or have any questions. No part of this manual and/or databases may be reproduced or transmitted in any form or by any means, electronic or mechanical, including photocopying, recording, or information storage and retrieval systems, for any purpose, without the express written permission of Best Access Systems.

This document is distributed as is, without warranty of any kind, either express or implied, respecting the contents of this book, including but not limited to implied warranties for the publication's quality, performance, merchantability, or fitness for any particular purpose. Neither Best Access Systems, nor its dealers or distributors shall be liable to the user or any other person or entity with respect to any liability, loss, or damage caused or alleged to be caused directly or indirectly by this publication.

Masterkey codes are owned by BEST and constitute confidential and proprietary information. BEST will seek to protect Masterkey codes by all legal means necessary, including, but not limited to, seeking injunctive relief and/or a suit for damages.

The Life Safety Code is a registered trademark of the National Fire Protection Association.

Written and designed by Best Access Systems and Avalon Group, Inc., Indianapolis, Indiana.

T61807 Rev - 1413243 ER7991-6 October 2001

CONTENTS

FIGURES VII

GETTING STARTED 1-1

- Introduction 1-1
- Documentation package 1-2
- Technical support 1-2
 - Support services 1-2
 - Telephone and web technical support 1-2
 - Training seminars 1-2

OVERVIEW OF A MASTERKEY SYSTEM 2-1

- Understanding the BEST difference 2-2
 - Benefits 2-2
 - Support from BEST 2-2
 - Training 2-2
 - BEST warranty 2-3
- Defining a masterkey system 2-4
 - Definition of a masterkey system 2-4
 - General design guidelines 2-4
 - Product family diagram 2-5
 - Interchangeable core 2-6
 - Keys 2-6
 - Keyways 2-7
 - Codes 2-8
- System organization and size 2-8
- System security 2-9
- Key and core control 2-10
 - Common control problems 2-10
 - G-Series forms 2-10
 - Keystone 600 Software 2-10

PARTS 3-1

- Overview of the BEST core 3-2
 - Core with segments, springs, and caps 3-2
 - Cross-section view of a core 3-2
- Overview of the BEST key 3-3
 - Diagram of an operating key 3-3
- Tools 3-4
 - Stamping tools 3-5
 - Lubrication items 3-5

OPTIONS AND APPLICATIONS 4-1

- Keyway options 4-2
- Special options and applications 4-3

CHANGES TO THE A4 SYSTEM 5-1

- Determining your needs 5-2
 - Questions to consider 5-2
- Working with BEST 5-2
 - Surveying the facility 5-2
 - Designing the schematic 5-4
 - Obtaining BEST codes 5-7
- Re-lock options 5-9

SERVICE AND MAINTENANCE 6-1

- A4 System basic procedures overview 6-2
 - Combining cores 6-2
 - Cutting keys 6-3
 - Stamping cores and keys 6-3
 - Installing cores 6-4
- Developing a key control system 6-5
 - Purpose of a key control system 6-5
 - Objectives of a key control system 6-5
 - Updating key and core records 6-5
 - G-Series cards and equipment 6-6
 - Procedures to administer your key control system 6-13
 - Sample key agreements 6-13
 - Issuing and returning keys 6-14
 - When keys are lost or stolen 6-15
 - Adding, removing and changing cores 6-15
 - Planning for emergencies 6-16
- Parts servicing 6-17
- General core maintenance 6-17

GLOSSARY A-1

INDEX B-1

FIGURES

OVERVIEW OF A MASTERKEY SYSTEM

- Product family diagram 2-5
- Sample masterkey hierarchy 2-7

PARTS

- Segments, springs, and caps 3-2
- Cross-section view of core 3-2
- Standard key features 3-3
- Tools used for servicing cores and keys 3-4
- Stamping tools 3-5
- Lubrication items 3-5

CHANGES TO THE A4 SYSTEM

- Sample site survey 5-3
- Sample keying schematic for buildings 5-5
- Sample keying schematic for departments 5-6
- Sample code sheet 5-8

SERVICE AND MAINTENANCE

- Door Number card 6-7
- Core Number card 6-7
- Key Marking card 6-8
- Employee Name card 6-8
- Key Request card 6-9
- Key Receipt card 6-9
- Lock Request card 6-10

Safety Lock Opening Request card	6-10
Lost Key Report card	6-11
Key envelope	6-11
Core envelope	6-12
Key Return tag	6-12

1

GETTING STARTED

INTRODUCTION

The *A4 System Service Manual* contains essential information to help you maintain your A4 System.

DOCUMENTATION PACKAGE

The following documentation is available to help you with the installation, start-up, and maintenance of your A4 System.

The installation and assembly instructions also can be ordered separately:

Document Title	Doc. No.
Core and Key Service Manual	T35527
Key Combinator Service Manual	T35532
Keystone 600 Getting Started Guide	E-774

TECHNICAL SUPPORT

Support services

When you have a question about the A4 System, your first resource for help is the *A4 System Service Manual*. If you cannot find a satisfactory answer, contact your local BEST Representative.

Telephone and web technical support

A factory-trained Certified Product Specialist (CPS) is available in your area whenever you need help. Before you call, however, please make sure that the product is in your immediate vicinity, and that you are prepared to give the following information:

- what happened and what you were doing when the problem arose
- what you have done so far to correct the problem.

Best Access Systems Representatives provide telephone technical support for all A4 System products. You may locate the Representative nearest you by calling (317) 849-2250 Monday through Friday, between 7:00 a.m. and 4:00 p.m. eastern standard time; or visit the web page, www.BestAccess.com.

Training seminars

BEST holds training sessions for its customers. The seminars are specifically designed for BEST end-users who have a registered BEST Masterkey system and registered BEST security equipment. If you are interested, you may contact your local BEST Representative for details.

2

OVERVIEW OF A MASTERKEY SYSTEM

This chapter discusses the benefits of a BEST system and defines how a masterkey system works. It also describes some of the components of a masterkey system such as interchangeable cores, keys, and codes. Finally, it provides guidelines for protecting a masterkey system.

UNDERSTANDING THE BEST DIFFERENCE

Best Access Systems has positioned itself to be your complete provider for access security systems. Our sales team has been trained to analyze the specific needs of your facility and recommend products and solutions that will most effectively address your access control requirements.

Benefits By choosing BEST, you are automatically guaranteed resources to help you with all of your security needs including:

- full installation services for all systems' products
- staff training services for various product lines and processes
- 24-hour assistance and consultation for any security need
- full specification preparation for new construction
- superior product availability and delivery.

Support from BEST Your BEST Representative will support you in all aspects of administering the system provided by BEST including:

- security consulting for all phases of security administration
- designing customized access control systems
- customizing a masterkey system for any size facility
- maintaining accurate records of the system
- expanding the system in the future.

Training **In-house system maintenance and service**

BEST Representatives provide local inventories, expertise, and training in servicing BEST's security system. Formal training is available to help you develop an in-house service department as well as to give you the ability to:

- combine cores
- recombine cores
- cut keys
- program and maintain electronics
- maintain lock hardware.

Formal training is available from BEST with special "Advanced Systems Curriculum" training being offered by the corporate factory headquarters.

BEST warranty BEST warrants that all of its products sold under its trade name are free of defects in materials, workmanship and operation, normal wear and tear excepted, for a period of three years from the date of sale to the original purchaser. BEST does not, however, warrant against defects that may be due to improper uses or installation, poor or no maintenance, shipping and/or handling, improper storage, accident, abuse or unauthorized service. BEST cannot be responsible for services provided by other companies to the system. Contacting your BEST Representative for installation and maintenance needs will ensure that you keep your warranty. The liability of BEST under this warranty is limited to the repair or replacement of any product covered by the warranty.

DEFINING A MASTERKEY SYSTEM

Definition of a masterkey system

A masterkey system is often misunderstood because it is not a tangible product and can have many variations. A BEST Masterkey system can be customized to meet any particular customer needs.

Masterkeying is a mathematical process that shows the number of different combinations available within a given plan and allows all cores to be combined into your system. It also assists the user in controlling the doors that people can access in the given facility.

Several security levels of keys are usually able to operate a single lock in a masterkey system. This feature offers flexibility as well as control to your system. Careful planning and consultation with your BEST Representative can help you maximize the benefits and avoid common pitfalls of a masterkey system. In most systems, 7-pin cores are used because they permit more combinations and allow greater flexibility for future expansion.

General design guidelines

BEST Representatives use the following guidelines when designing a customized masterkey system for the customer:

- Design the keying system around the function of the building and not the actual organization, if possible.
- Develop a simple design.
- Try to predict where, when, and how people move throughout the building.
- Plan for any future expansion that may be needed.
- Recognize the families of keys that are established, because they can restrict the flexibility of the system.

Moreover, once a system is established, it is not necessary to use all of your codes at one time. Codes may be set up as needed. Then, if growth occurs, BEST refers to its own secure files for the remaining available combinations. This activity is conducted as directed by the customer. It is the customer's responsibility to keep track of which core markings have been used in a given series.

**Product family
diagram**

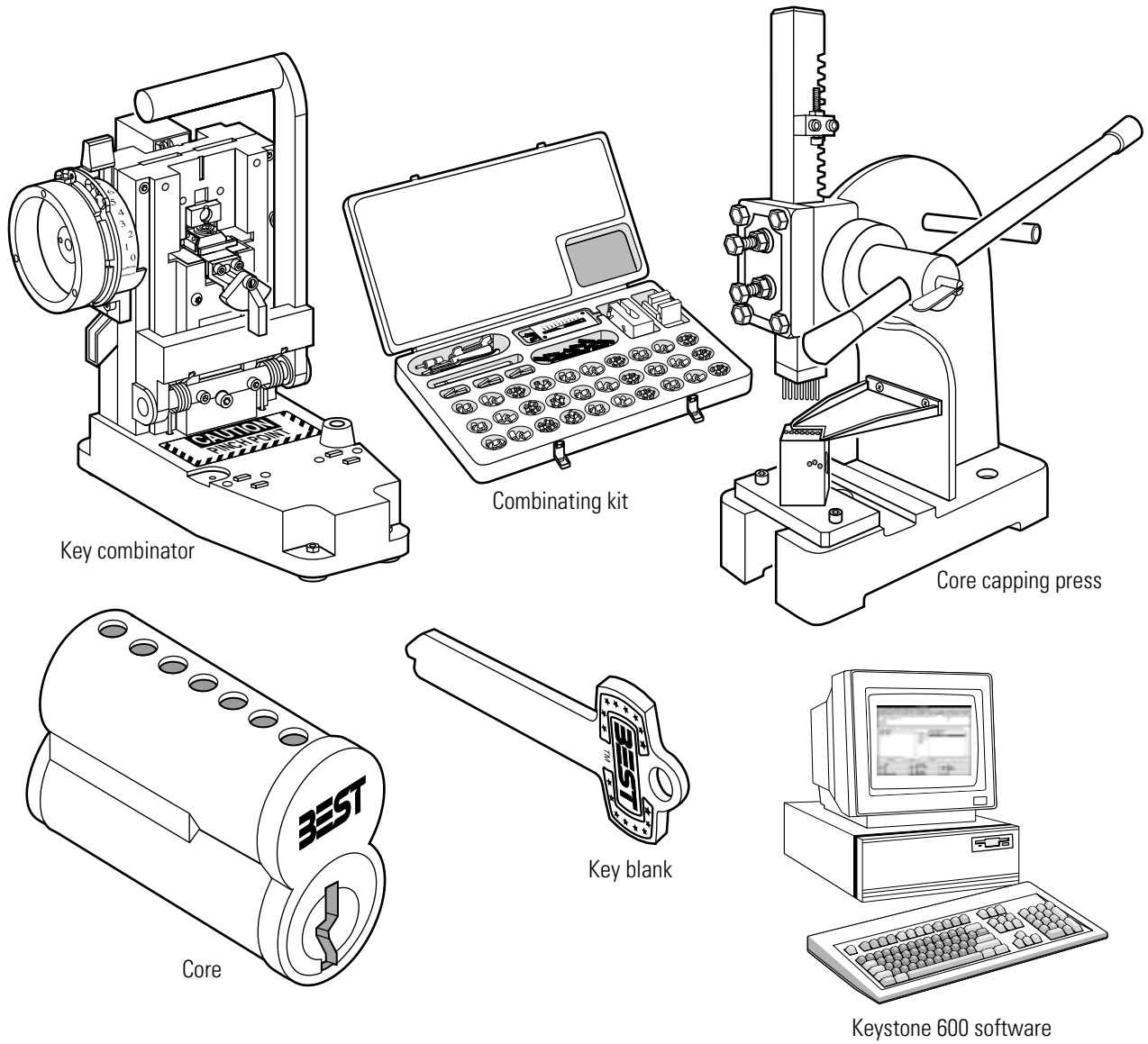

Figure 2.1 Product family diagram

Interchangeable core The standard figure-8 core that is interchangeable throughout the entire product line is a major feature of BEST. This interchangeability permits BEST locks of any type, size, or style to be masterkeyed into one system. Therefore your system can easily expand to include new facilities. Also, no BEST core needs alterations to fit any other BEST lock. You simply remove the core with the control key and insert a new core that operates by different keys. This unique feature lets you perform a re-lock in seconds. See [page 5-9](#).

Keys It is important to understand several key terms to more fully comprehend the concepts of masterkeying. See [Figure 2.2](#).

Control key

The control key installs and removes the interchangeable core in your BEST system. The control key has the same security level as a grandmaster and must receive the same level of protection.

Grandmaster key

The grandmaster key operates all locks in a masterkey system (unless locks are specifically excluded from the grandmaster for security or safety reasons such as cash boxes, drug cabinets, hazardous waste areas, and so forth).

Master key

The master key operates a large group of locks. For example, one master key can have access to an entire building, floor, or department.

Submaster key

The submaster key operates a smaller group of locks that are part of a master group.

Operating key

The individual key is also known as the operating key and is the lowest level key. This key operates only one lock or keyed-alike group of locks. (This type of key is also called “change key” in the locksmith industry.)

It is important to note that keying is not limited to just the organization of the keys listed above. More levels in the hierarchy may be created if needed. For example, a sub-submaster key level may be added.

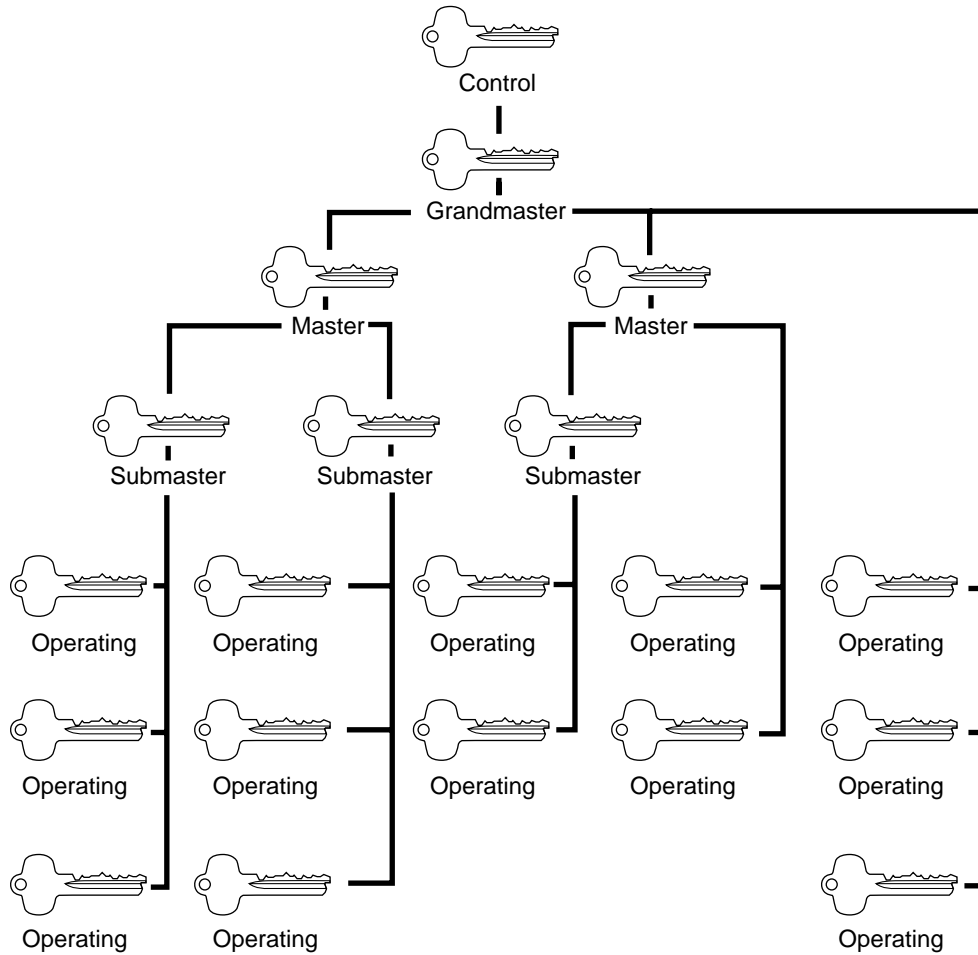

Figure 2.2 Sample masterkey hierarchy

Keyways The keyway of a core is a specific design or shape of the key blade and is manufactured into the core plug. This specific design keeps keys of other keyways from working in a dissimilar core. The keyway shapes can be grouped into the following categories:

- Standard keyways
- Restricted keyways
- Patented keyways.

Codes One of the most significant elements of a masterkey system is the codes on which the entire system is based. Codes are the number sequences that directly relate to key cuts and indirectly relate to the pin segments or combinations within the interchangeable core. Codes originate at the corporate headquarters and are used by BEST offices to establish systems around the world. All codes remain proprietary property of BEST.

Codes are only supplied to the customer when BEST authorized service equipment has been ordered and received. Once generated, the codes arrive in the form of a code sheet or bitting list. This sheet then becomes a printed record of your keying system. It contains information about your system that is highly confidential. See [page 5-8](#) for an example of a code sheet.

SYSTEM ORGANIZATION AND SIZE

The size of your system is determined by the following factors:

- The number of individual locks you need
- The pin size of your cores
- The code system you need.

The number of actual locks you require is taken from the information you received from the site survey. A general rule of thumb is to estimate your future core needs by doubling the number of locks determined by the site survey. Then you will have codes available when you need to re-key one or several locks due to lost or stolen keys. Planning for extra codes will also let you add an additional building or wing under the same system.

The pin size of cores refers to the number of barrels in each core. BEST uses 7-pin cores as a standard in order to provide greater flexibility in the number of combinations that can be generated. However, if your existing system uses 5-pin or 6-pin cores, BEST offers these pin sizes as well. Using 5-pin or 6-pin, though, will decrease the number of total combinations that are available to you.

Manufacturing tolerances, as designed, are a vital factor in consistent key control. For each specific system, keys and core segments must be designed to mate exactly as coded. BEST holds a very close tolerance throughout its product lines.

Your BEST Representative can help you determine which options not only meet your facility's current needs, but also provide maximum flexibility and efficiency as your system evolves.

SYSTEM SECURITY

To increase the level of security within your system, you need to protect sensitive security products or information. These may include:

- Code sheets
- Service equipment
- Authorized security personnel contacts
- Key/core inventory.

BEST will help you with these procedures by maintaining code records at local BEST offices. In addition, authorized security contacts are kept on file. These contacts are people who are responsible for receiving all products and information. Security policies and procedures such as these help assure the integrity of your keying system.

KEY AND CORE CONTROL

A good mechanical locking system involves more than hardware. A key and core control system is a recording and filing plan that provides complete information on keying, doors, locks, and personnel. The system should include formal policies and procedures to regulate the distribution and control of key, core and code issuance. The following five elements must be controlled in all lock and key systems in order to maintain security:

- Keys
- Cores
- Forms
- Doors
- People.

Common control problems

Based on a survey conducted by BEST, security system users revealed the following problems with managing and administering the locking system:

- Loss of keys—either lost or stolen
- Not retrieving keys from employees that have been replaced or have retired
- Management indifference to security problems
- Theft—internal and external
- Too many keys issued
- Poor management of records resulting in keys being misplaced or stolen by employees within the facility
- Code expansion without BEST involvement
- Too many people involved with the system.

G-Series forms

Keeping accurate and up-to-date records is essential for the overall management of a BEST system. It is important to use adequate forms, in detail, to account for all keys/cores in your facility. The BEST G-Series form system provides color coding, cross-referencing, and space for continuous relocks and key changes. Contact your BEST Representative to obtain these forms.

Keystone 600 Software

For larger systems (systems with 100 or more users), the Keystone 600 Software is the recommended means of maintaining the A4 System. BEST's Keystone 600 key and core control software is a valuable tool for managing records. This user-friendly, Windows-based system allows for expedited entry of data and the generation of multiple standard reports. This program records, cross-references, and accesses all key and core information. Modeled after the proven G-Series form system, Keystone 600 helps you to efficiently make the transition from a manual system to a computer.

3

PARTS

The following pages contain descriptions and figures for BEST A4 System cores, keys, and tools for servicing them. To order these items, refer to the *Core and Key Service Manual* (T35527).

OVERVIEW OF THE BEST CORE

Core with segments, springs, and caps

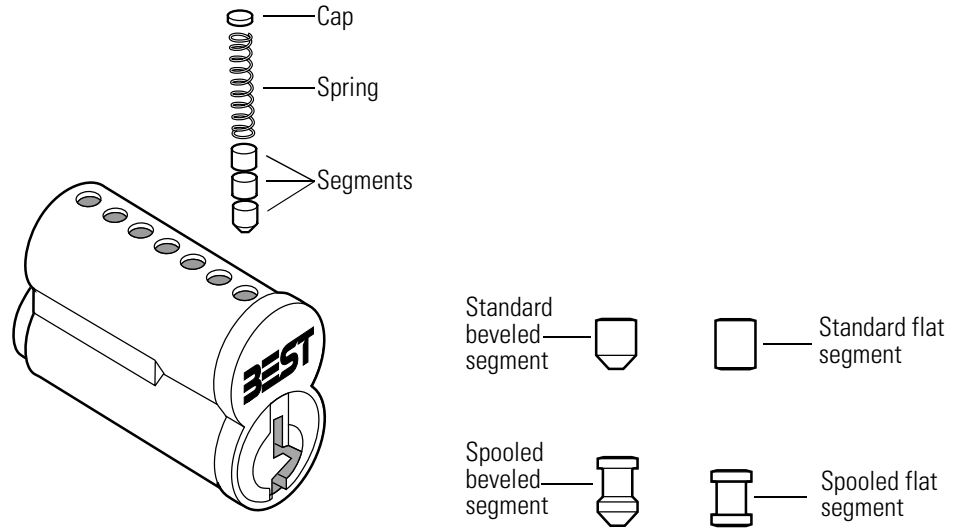

Figure 3.1 Segments, springs, and caps

Cross-section view of a core

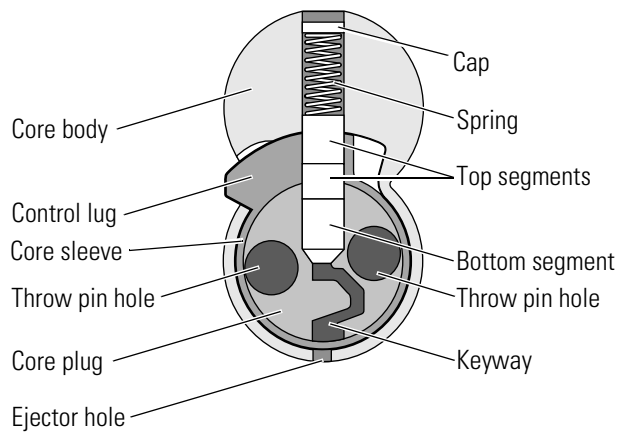

Figure 3.2 Cross-section view of core

OVERVIEW OF THE BEST KEY

Diagram of an operating key

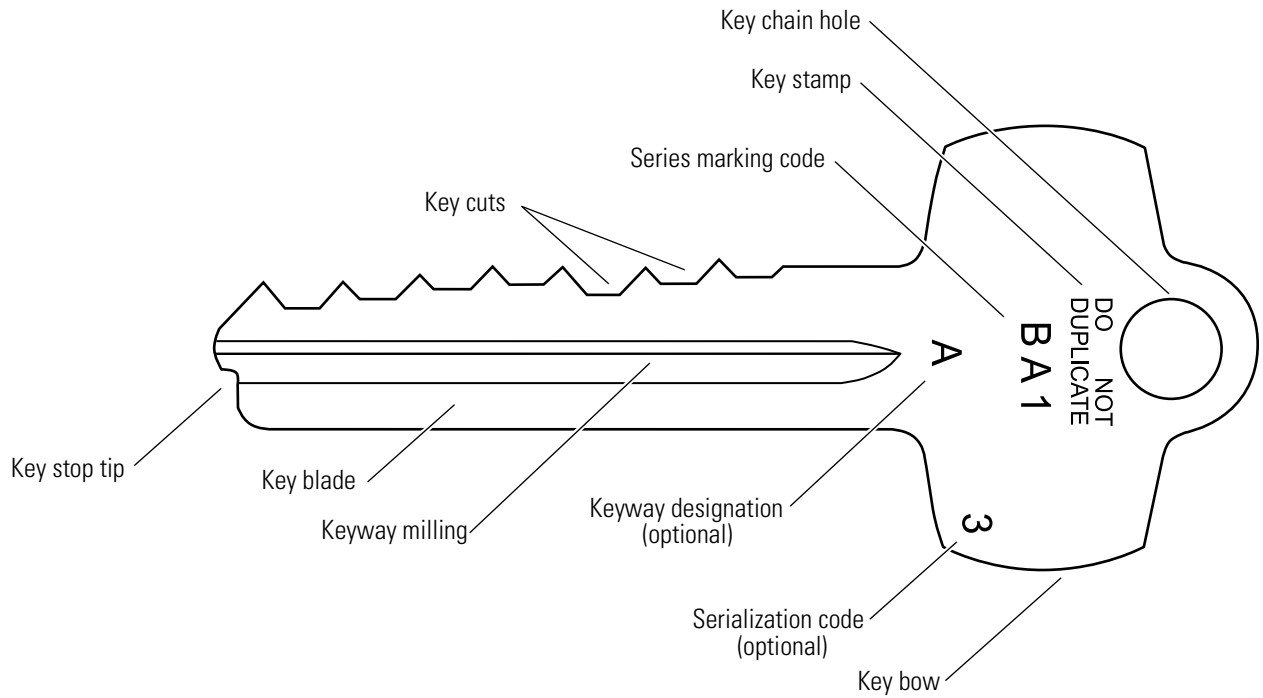

Figure 3.3 Standard key features

TOOLS

The following tools are used for servicing cores and keys.

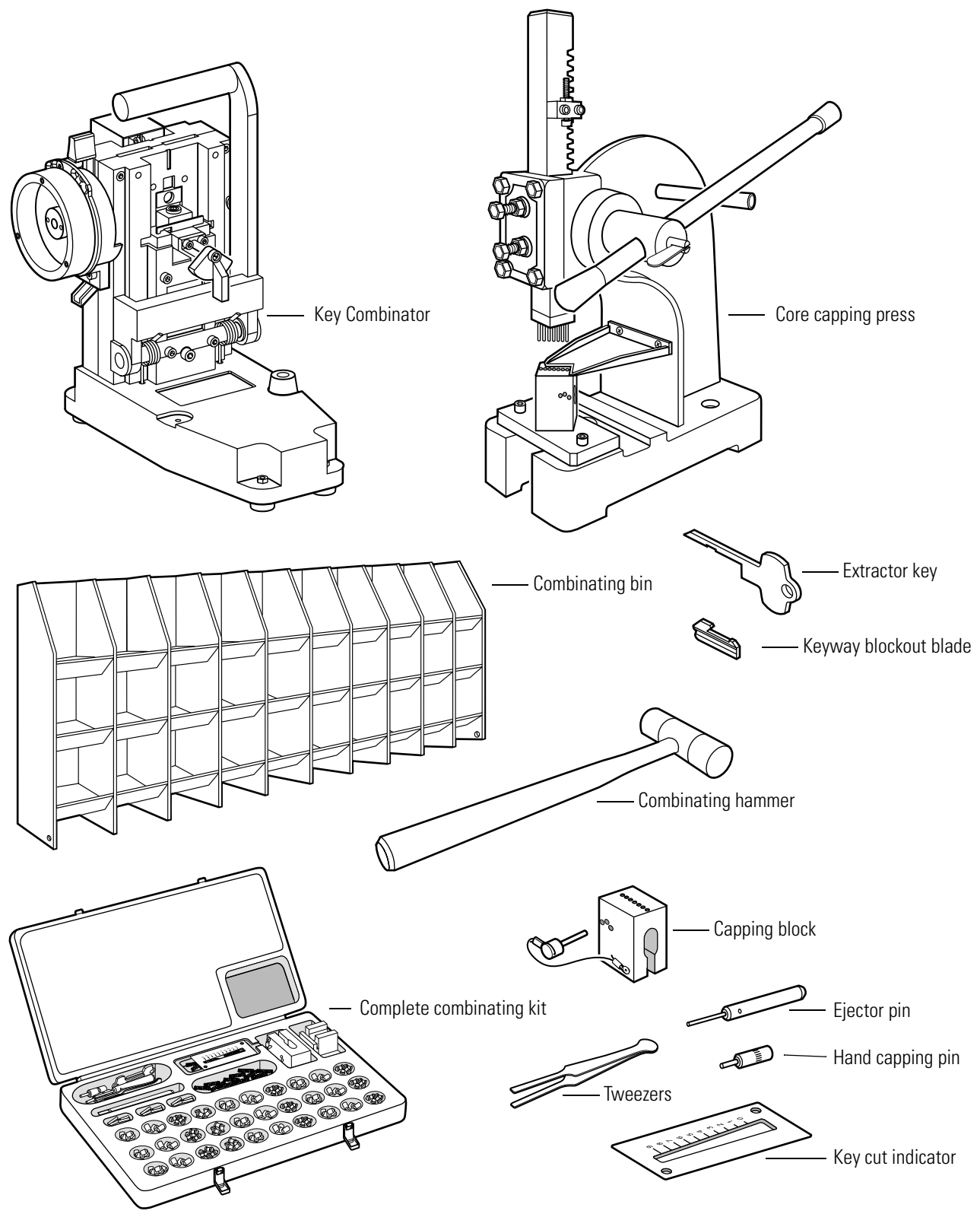

Figure 3.4 Tools used for servicing cores and keys

Stamping tools The following tools are used for stamping cores and keys in your system.

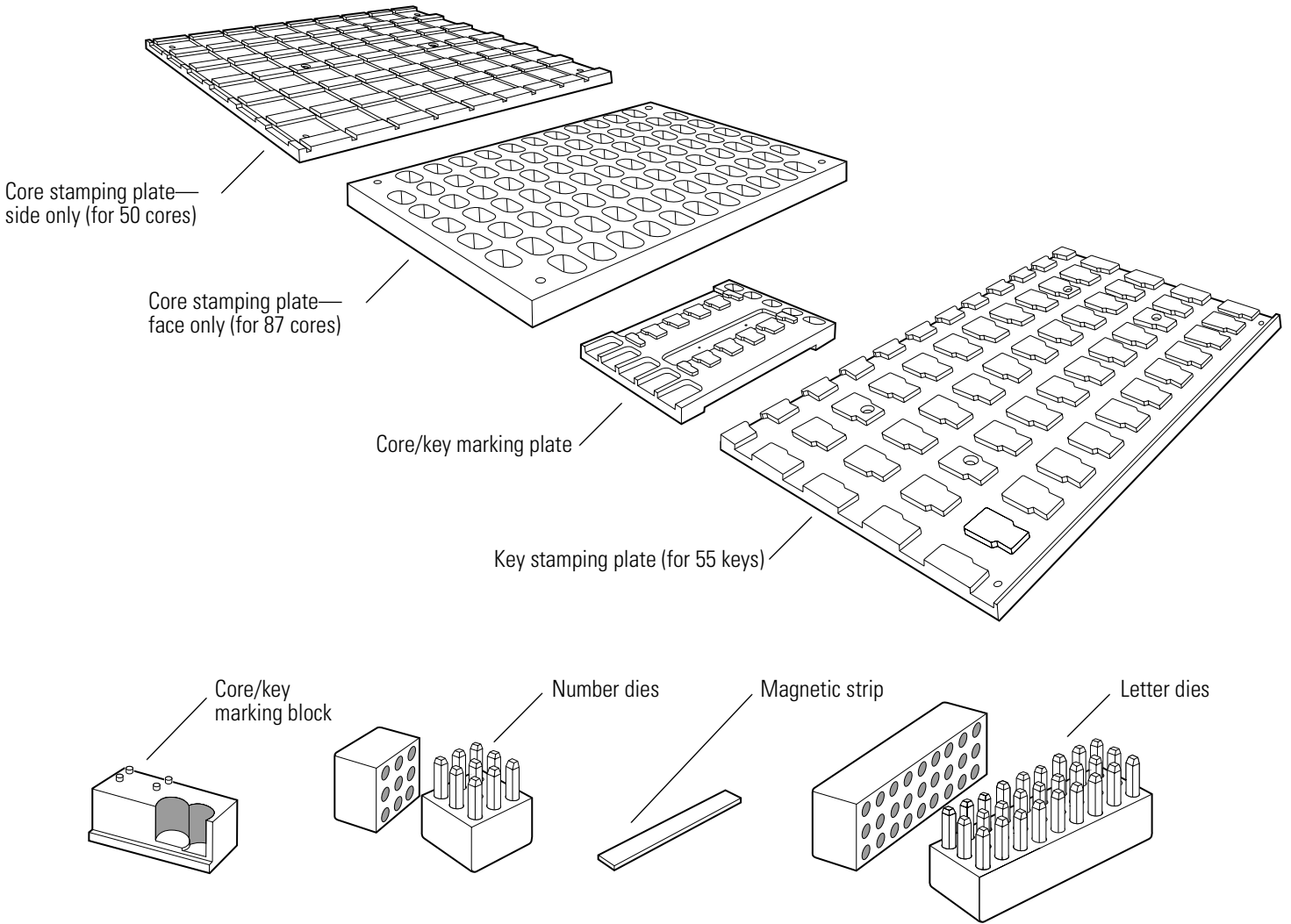

Figure 3.5 Stamping tools

Lubrication items The following items are used to lubricate cores.

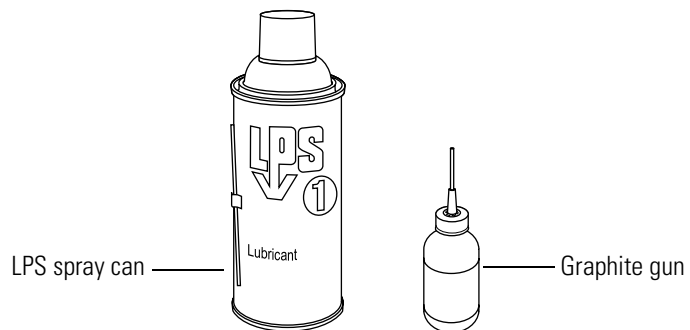

Figure 3.6 Lubrication items

4

OPTIONS AND APPLICATIONS

This chapter contains keyway options and special core options with their applications for the BEST A4 System.

KEYWAY OPTIONS

The following table describes possible keyway options that BEST offers for the A4 System.

Keying option[†]	Description
Standard keyway	BEST offers standard keyways for general use by customers that are compatible with existing systems and provide a cost effective means for system expansion.
Restricted keyway	BEST offers non-patented keyways, which BEST restricts by volume and proximity usage for limited distribution.
Patented keyway	BEST offers patented keyways that cannot legally be duplicated by other manufacturers.

[†] Multi-milled key blanks are available for up to a family of four keyways. Keyway families are typically used for only the highest key levels. These keyways are chosen when you have an existing system and have no available codes; or you have a large system and need more flexibility.

SPECIAL OPTIONS AND APPLICATIONS

The following table describes special core options that BEST offers for the A4 System and gives examples for when they are used.

Option	Description	Application
Key trap core	<p>When the key is inserted into the core and is turned, the key is trapped in the core. The key cannot be returned vertically nor withdrawn from the core. The core and trapped key must be drilled out of the lock.</p> <p>This special core is modified at the factory to match the key that you want to trap.</p>	Eliminates a key from the system by trapping it in the core. This option is useful if a key has been lost, or if someone has a key and will not return it.
Keyway blackout blade [†]	This blade prevents any and all keys from being inserted in a core. A special extractor key must be used in order to remove the blackout blade from the keyway.	Prevents keys from having access to a given entrance. This option is useful to have in case of a natural disaster or a specified job action such as a strike or lockout.
Wear resistant core	Hardened stainless steel segments are used as the bottom segments in each barrel of the core.	Provides longer life for cores in high traffic areas such as entry doors or other frequently used doors.
Pick resistant core	Spooled segments are used as the top and bottom segments in each barrel of the core.	Provides enhanced resistance to picking the core. This option is useful for high security areas such as narcotics rooms, special equipment rooms, or cash offices.
Drill resistant core	Hardened ball bearings are used in the throw pin holes and hardened stainless steel segments are used at the top and bottom segments in the first two barrels of the core.	Provides enhanced resistance to drilling the core. This option provides an added measure of security for areas listed above.
Pick and drill resistant core	Hardened ball bearings are used in the throw pin holes and hardened stainless steel segments are used as the top and bottom segments in the first two barrels of the core. Spooled segments are used as the top and bottom segments in each remaining barrel of the core.	Provides enhanced resistance to picking and drilling of the core. This option provides an added measure of security for areas listed above.
Core dust cover	Stainless steel spring-loaded dust cover is installed over the keyway.	<p>Prevents the keyway from accumulating dust and dirt. This option is useful for cores exposed to the elements such as doors in high humidity climates, selected doors in chemical plants, or for low use exterior doors.</p> <p>Note: If the core is housed in a cylinder, use the cylinder dust cover instead of the core dust cover for maximum protection.</p>

[†] See [page 3-4](#) for illustrations of the keyway blackout blade and extractor key.

5

CHANGES TO THE A4 SYSTEM

This chapter contains guidelines for determining your A4 System needs, guidelines for working with BEST when making changes to the A4 System, and also includes possible re-lock options.

DETERMINING YOUR NEEDS

Questions to consider There are several questions that customers should consider when assessing what changes need to be made to the A4 System including the following:

- How many keys did I originally plan for?
- How many new locks do I need now and approximately how many will I need in the future?
- How many codes do I have left for my system?
- How many master keys do I want (see [page 2-8](#))?
- Are there any special options or adaptations that I want (see [page 4-3](#))?
- Do I have specific security needs or concerns about re-locks (see [page 5-9](#))?

The way that your system was originally customized may affect how you go about making changes or expanding the system. For instance, if you did not originally plan to add on to your facility, then there may not be enough codes saved to do so. It is necessary to contact your BEST Representative to help you determine how to resolve any issues that may arise.

WORKING WITH BEST

Surveying the facility After the initial assessment of the system has been made, a physical site survey is conducted for new areas of the facility. Your BEST Representative will inspect and assess all of the requirements associated with securing your facility. The goal of a site survey is to systematically gather information that allows a thorough analysis of each access point. This analysis helps identify all necessary hardware requirements. It also organizes valuable information about the feasibility of integrating additional buildings, wings, and so forth into a system. The survey can then be used with the system schematic to determine how each lock is to be keyed/programmed. For an example of a site survey, see [Figure 5.1](#).

SCHEDULE OF LOCKS								
NAME XYZ Corporation					Order No.	Page		
ADDRESS 5555 Z STREET Hometown, USA 55555					SGC-41781	1 of 6		
					Account No.	Date		
					1-XXXX	00-00-00		
					Approved by:			
Item No.	Location	Qty	Catalog Number, Hand of Door	Finish	Core Mak	Keys Cards	Miscellaneous	
1	Door 100 Main Office	2	35HV7EV15-KP-RH	626	AA	1 / 20		
2	Door 101 Accounting Office	2	35H-7EW15-M-RH	626	AA2X	2	Oper. by AA2-AA4	
3	Door 102 Time Office	1	93K-7AB15-A-STK	626	AB1	2		
4	Door 103 Cash Room	1 1 1	35H7 EWEU15M-IDH Mag Stripe Card Reader Electrified Hinge	626	AA3	1 / 4	RHRB-Hollow metal door approx. 50' to controller	
5	Door 105 Purchasing	1 1 1 1	1E-74-C181-R2	626	AA1		Oper. by AA1-AA16	
6	Door 110 Exterior Side Ent.	1	1E72 Electric Strike Mag Stripe Card Reader Request to Exit motion	626	AA4		Aluminum frame glass door rim panic 100' to controller	
7	Door 120 Research	1	94KV7DV15-MS-STK	626	AA1X	0		
8	<u>Main Factory</u> Elevators at Entrance	4	1W-7B2	626	F	1		
9	Door 130 Engineering Offices	3	83T7K-STK	606	FA1	20		
10	Tool Boxes	2	41B72T		FB1-FB120	240		

Figure 5.1 Sample site survey

Designing the schematic

The keying schematic is a plan or blueprint that illustrates the various levels of security you need for the BEST system. These levels are defined and designated into specific groups. The schematic design is similar to an organizational chart, as shown in [Figure 5.2](#) and [Figure 5.3](#).

General guidelines

When designing a masterkey system schematic, BEST Representatives follow these guidelines:

- Initially structure a control and grandmaster level.
- Determine how the facility is to be grouped as far as buildings, locations, wings, floors, departments, and so forth. The first grouping or level usually determines the master level of keys.
- Develop a second level of control within a building, floor, or wherever necessary by creating a submaster group. Additional levels or groups can be created if needed.
- Determine codes for masters, submasters, and any additional groupings.
- Design special levels of access or restriction for additional system flexibility.

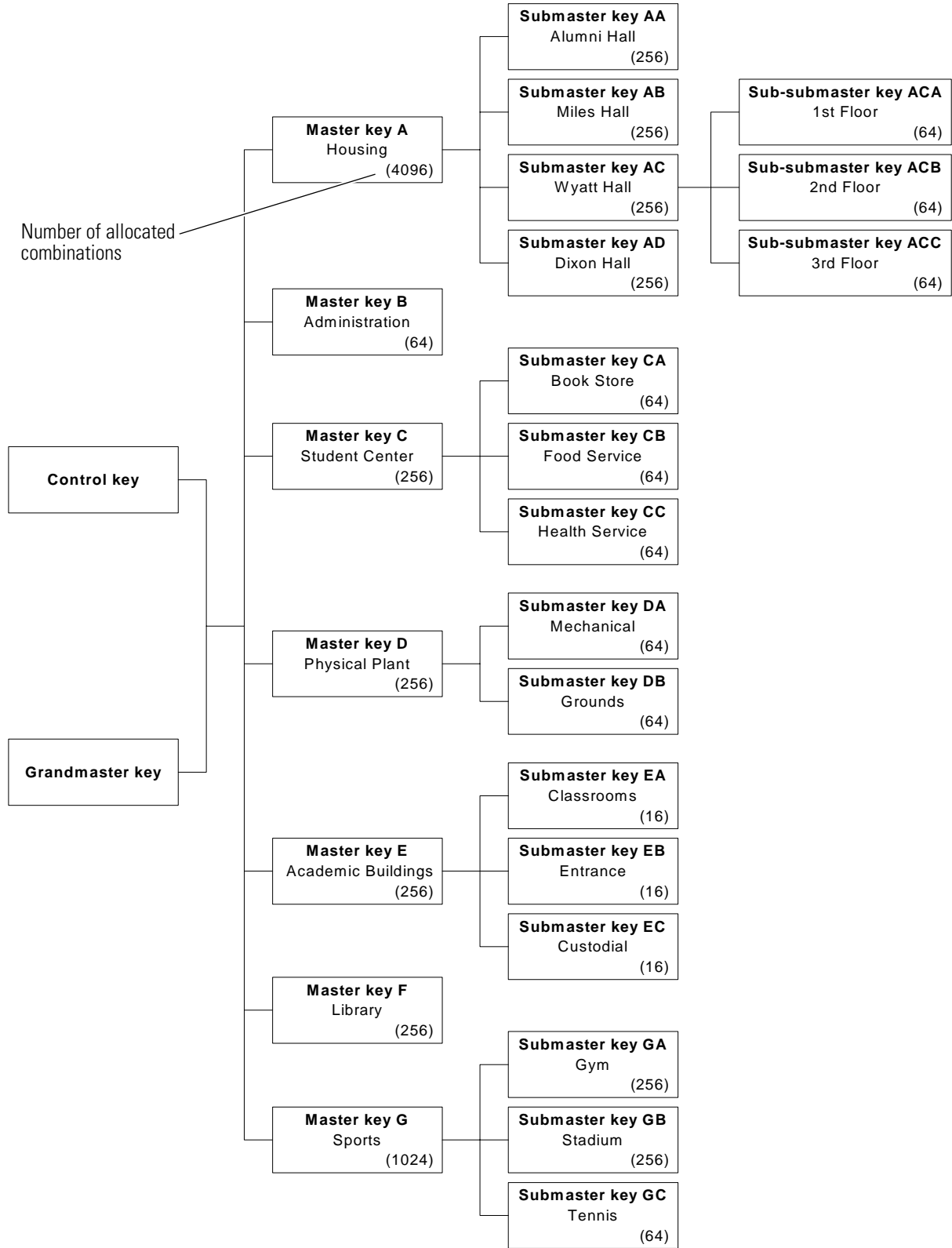

Figure 5.2 Sample keying schematic for buildings

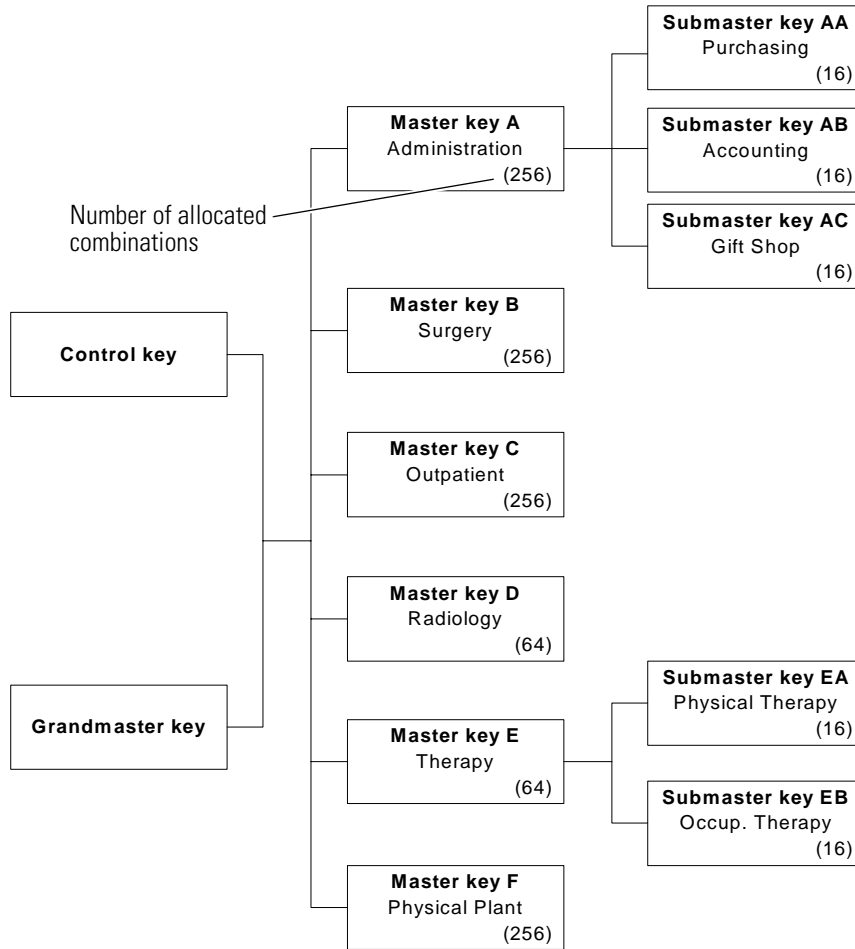

Figure 5.3 Sample keying schematic for departments

Obtaining BEST codes

The code sheets you receive from BEST are a list of numbers used for cutting keys and for determining pin segments when combining cores. See [Figure 5.4](#).



Do not try to create your own coding system. Improper code design could lead to security violations and the loss of your warranty. Obtain all of your codes directly from BEST.

The code sheet is a printed record of the keying system established for your use, which includes:

- Each level of key cuts
- Size of each level in terms of available codes
- Keyway information
- Key and core marking symbols
- Your customer account number
- Key stamp information
- Date that codes were issued
- Location of core stamping.

Note: BEST maintains code records in an authorized restricted area limited to masterkey personnel only. Code charts are sent by registered mail to authorized persons.

CODE PAGE					PROPRIETARY PROPERTY OF BEST ACCESS SYSTEMS					PAGE 1
SYSTEM ID:		16222		ORDER NO: _____			ACCOUNT NO:			100200
DATE		: 30-AUG-2001					LOC ID			: 1
PINS: 7		TYPE:A4		MARK ON: S		KEYWAY: M		KEYSTAMP: 280 X 800		
		05 20 02 1		SC		56		05 20 02 1		
		05 24 21 0		C				05 24 21 0		
		33 31 13 1		GM		56		33 31 13 1		
		33 31 13 2		M		56A		33 31 13 2		
CORE MARK		KEY CODE		OP BY		CORE MARK		KEY CODE		
56A-1		33 31 24 2								
56A-2		33 31 34 2								
56A-3		33 31 44 2								
56A-4		33 31 54 2								
56A-5		33 31 04 2								
56A-6		33 31 25 2								
56A-7		33 31 35 2								
56A-8		33 31 45 2								
56A-9		33 31 55 2								
56A-10		33 31 05 2								
56A-11		33 31 20 2								
56A-12		33 31 30 2								
56A-13		33 31 40 2								
56A-14		33 31 50 2								
56A-15		33 31 00 2								
56A-16		33 31 21 2								
56A-17		33 31 31 2								
56A-18		33 31 41 2								
56A-19		33 31 51 2								
56A-20		33 31 01 2								
56A-21		33 31 22 2								
56A-22		33 31 32 2								
56A-23		33 31 42 2								
56A-24		33 31 52 2								
56A-25		33 31 02 2								

Figure 5.4 Sample code sheet

RE-LOCK OPTIONS

The process of adapting existing locks to meet new needs is referred to as a “re-lock.” Re-locks within your facility can vary from a simple one-core re-lock to complex total re-locks. Some of the variations in masterkeying which may apply to established BEST systems are listed below.

Option	Description
Core change	replace all cores with newly combined cores on an emergency (immediate) or periodic (pre-planned) basis
Recombine total core	recombine every barrel in an existing core
Partial recombination	recombine some barrels in an existing core
Departmental re-lock	replace all cores in a department with newly combined cores on a periodic basis
Rotation of cores	preplanned from one floor or department to another
Master change	contact your BEST Representative for more information
New series of codes	obtain new codes from your BEST Representative
New keyway	contact your BEST Representative for more information
New system	contact your BEST Representative for more information
Total corporate re-lock	contact your BEST Representative for more information

Guidelines for performing re-locks

When performing any re-lock procedure, be sure to follow these guidelines to ensure the security of the system:

- Use only authorized system codes from BEST.
- Use the code sheet to determine which barrels need to be combined.
- Recombine only the barrels necessary for the new combination.
- Always record which combinations have been used to avoid any duplications.

6

SERVICE AND MAINTENANCE

This chapter contains information for servicing and maintaining components of the A4 System. It includes references to the appropriate BEST manuals where you can get more detailed instructions.

A4 SYSTEM BASIC PROCEDURES OVERVIEW

Combining cores

Overview of using a code sheet

When you need to combine new cores, you should get code sheets from your BEST Representative. For an illustrated example of a code sheet, see [page 5-8](#).

For detailed instructions with illustrations on combining cores, see the *Core and Key Service Manual (T35527)* or contact your BEST Representative.

General guidelines for combining cores

- Use only authorized system codes from BEST.
- Begin combining from the rear of the core and work your way to the face of the core.
- Always complete the pin loading process for each individual barrel before proceeding to the next barrel.
- Never split pin segments. For example, do not use two number 2 pin segments in place of a number 4.

Basic steps for combining cores

1. Make sure that the core plug turns freely before you begin combining.
2. Align the barrels to receive segments.
3. Load the segments into the core.
4. Load one spring per barrel.
5. Place one cap onto each barrel.
6. Check the core for proper operation by inserting a key in the core. If you can insert, turn, and remove the key easily, then the core and key are working properly.
7. Check the control key for proper installation by inserting the control key into the core and turning it. If you can turn the key 15° clockwise and the core can be removed, then the core and control key are working properly.

Cutting keys Keys may be cut to any combination up to seven digits long using your BEST key combinator. If your organization needs a key combinator, contact your BEST Representative.

For detailed instructions with illustrations on cutting keys, see the *Key Combinator Service Manual* (T35532) or contact your BEST Representative.



Always keep fingers and hands out of the way of moving parts. Be especially careful of the pinch point between the base and operating handle.

Basic steps for cutting keys

Use BEST original key blanks to ensure consistent results. With the machine bolted down or free standing you can start cutting keys.

1. Load a key into the key combinator.
2. Cut the key.
3. Unload the key from the key combinator.
4. Test the key for proper measurements.

Stamping cores and keys

For detailed instructions on stamping cores and keys, contact your BEST Representative.

General guidelines for stamping cores and keys

To avoid causing any damage when stamping cores, follow these guidelines:

- Do not use a metal-headed hammer on cores and keys.
- Do not use excessive force to stamp core markings on the side of cores. Excessive force may cause the barrel opening to deform.
- Do not stamp the core on the bottom lobe. Stamp only the top lobe.

Basic steps for stamping cores and keys

1. Be sure that you have selected the appropriate die and that it is facing the correct direction.
2. Place the core/key into the selected holder to hold it in place.
3. Stamp the core/key with a ball-peen hammer.
4. Continue this process until the desired marking is complete.

Installing cores For more detailed instructions on how to properly install cores into locks, see the *Core and Key Service Manual* (T35527) or contact your BEST Representative.

Installing new cores

After you have combined new cores, you may choose to install them into the locks on your own. It is important to install cores in an undetectable pattern to ensure that your system is protected. It may be possible for someone to figure out the pattern if the cores are installed in the order in which they were combined.

Checking cores for proper installation

Once your cores have been installed in an undetectable order, be sure to check that they have been properly installed. Insert the operating key in the core. If you can insert the operating key, turn, and remove the key easily, the core and key are working properly installed.

Periodically test all of your keys, including the control, grandmaster, and operating keys in the core to make sure that the core is operating properly.

DEVELOPING A KEY CONTROL SYSTEM

Key control is one of the most important aspects of any security program. Without proper key control, unauthorized entry into your facility is possible. It is essential that each operating facility implement an adequate key control program.

Purpose of a key control system

Experience has shown that keys are often handled carelessly. They are loaned, duplicated, exposed to theft, abused, and lost. Often there are no up-to-date records tracking keys that have been distributed, keys that have been lost, keys that are still in the custody of employees no longer employed at the facility, and spare keys that have not been officially issued. At some locations, spare keys to important exterior doors are displayed in the open, sometimes even hanging on a nail inside the door that the key unlocks. To adequately protect company assets, you must eliminate such practices and implement formal, positive key controls. The guidelines below serve as the minimum standards of key control for all of your facilities.

A good key control system effectively manages any size network of locks by pinpointing the responsibility of each individual and by providing quick access to information on all locks, keys, and personnel. It also stores additional keys, lock parts, and service equipment. The system shows who has keys to which locks, and when each key has been issued or returned.

Objectives of a key control system

Develop a key control system with the following objectives in mind:

- Limit the number of keys distributed to individuals.
- Maintain a record of the location of every lock that is used in the facility, with the number of the BEST core assigned to the lock.
- Maintain a record of the location of all lock numbers and BEST cores.
- Maintain a record of all keys that have been issued, showing the number of the key and the name of the holder, as well as a record of keys not issued.
- Maintain a record of all keys held by each individual, with signatures for each key held.
- Securely store all key records, spare codes, spare keys, and key equipment.

Updating key and core records

It is important to update your key and core records when making changes to the masterkey system. When records are not properly updated, it becomes too difficult to maintain your high level of security. Unless information has been properly recorded, there can be no way to trace a key back to the proper holder.

General guidelines for recordkeeping

Accurate records allow management to track facts quickly and hold each employee accountable. The following tips will help you maintain your records:

- Keep key records on updated forms, not code sheets.
- Record every key issue and return immediately.
- Record every core placement and change immediately.

BEST recommends using the Keystone 600 software program when your system exceeds more than 150 individuals. Otherwise, BEST offers the G-Series paper forms to ensure effective key control.

G-Series cards and equipment

The following cards and equipment are essential to implement a key control program if you do not have the Keystone 600 software program. Contact your local BEST Representative to obtain the G-Series cards and equipment. Refer to the table below and the figures that follow for descriptions of the listed G-Series products.

Card	Description	Figure No.
G-10	Door Number card	Figure 6.1
G-11	CoreNumber card	Figure 6.2
G-12	Key Marking card	Figure 6.3
G-13	Employee Name card	Figure 6.4
G-271	Key Request card	Figure 6.5
G-275	Key Receipt card	Figure 6.6
G-274	Lock Request card	Figure 6.7
G-272	Safety Lock Opening Request card	Figure 6.8
G-276	Lost Key Report card	Figure 6.9
G-21	Key envelope	Figure 6.10
G-20	Core envelope	Figure 6.11
G-30	Key Return tag	Figure 6.12

Key Marking card

This card records all personnel carrying a specific key. It also indicates when that key was issued and returned.

KEY NUMBER			
Individual Key ID	NAME OF KEY HOLDER	DATE ISSUED	DATE RETURNED
KEY CONTROL		Printed in USA	BEST ACCESS SYSTEMS INDIANAPOLIS, IN 46250

Figure 6.3 Key Marking card

Employee Name card

This card records individual employee information. It also identifies keys that the individual carries and serves as a signed acknowledgement of internal policy and procedures. The agreement section is left blank so that you can write or stamp your company’s key agreement statement. For sample key agreements, see [page 6-13](#).

Last Name	First Name	Middle In.	Locker #	Clock #		
Agreement:						
Key Number	Signature	Date Issued	Issued by	Date Issued	Date Issued	Remarks
KEY CONTROL		Printed in USA	BEST ACCESS SYSTEMS INDIANAPOLIS, IN 46250	G-13	1284593	

Figure 6.4 Employee Name card

Key Request card

This card is used to request a key to be issued to employees for defined areas and requires an employee signature and date.

KEY REQUEST		
Last Name _____	First Name _____	Middle In. _____
To KEY CONTROL DEPARTMENT: I request that the above person be issued a key		
to open _____		
		
Signed _____	Position _____	Date _____
Approved by _____	Position _____	Date _____
KEY CONTROL	Printed in USA	BEST ACCESS SYSTEMS INDIANAPOLIS, IN 46250 G-271 1358979

Figure 6.5 Key Request card

Key Receipt card

This card records the name of the employee who has returned a key.

KEY RECEIPT		
To KEY CONTROL DEPARTMENT: Has received from _____		
Key number _____		
		
Signed _____	Position _____	Date _____
KEY CONTROL	Printed in USA	BEST ACCESS SYSTEMS INDIANAPOLIS, IN 46250 G-275 1359176

Figure 6.6 Key Receipt card

Lock Request card

This card is used to request that lock changes or additions take place.

LOCK REQUEST		
Last Name	First Name	Middle In.
To KEY CONTROL DEPARTMENT: the above named person requests the following lock changes or additions be made _____		
Reason for making the change _____		
Signed	Position	Date
Approved by	Position	Date
KEY CONTROL	Printed in USA	BEST ACCESS SYSTEMS INDIANAPOLIS, IN 46250 G-274 1359129

Figure 6.7 Lock Request card

Safety Lock Opening Request card

This card is used to authorize key control personnel to open a designated lock for a particular person.

SAFETY LOCK OPENING REQUEST		
Last Name	First Name	Middle In.
To KEY CONTROL DEPARTMENT: You are authorized to open the SAFETY LOCK belonging to the above named person _____		
Reason for making the change _____		
Signed	Position	Date
Approved by	Position	Date
KEY CONTROL	Printed in USA	BEST ACCESS SYSTEMS INDIANAPOLIS, IN 46250 G-273 1359019

Figure 6.8 Safety Lock Opening Request card

Lost Key Report card

This card is used to report when a key has been lost or stolen. The circumstances of the missing key can be listed here to give to the key control department.

LOST KEY REPORT		
_____ Last Name	_____ First Name	_____ Middle In.
To KEY CONTROL DEPARTMENT: This is to report that the above named person has lost his or her key on _____ under the following circumstances _____ _____ _____ _____ and requests that a replacement key be issued.		
_____ Signed	_____ Position	_____ Date
_____ Approved by	_____ Position	_____ Date
KEY CONTROL	Printed in USA	BEST ACCESS SYSTEMS INDIANAPOLIS, IN 46250
		G-276 1359815

Figure 6.9 Lost Key Report card

Key envelope

One envelope is used per spare key and can be filed numerically according to key markings. Keep all envelopes containing spare keys in a secure location.



Figure 6.10 Key envelope

Core envelope

One envelope is used per spare core and can be filed numerically according to core markings. Keep all envelopes containing cores in a secure location.

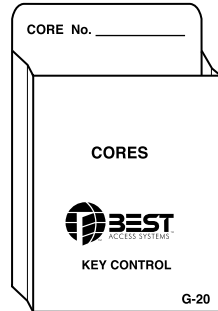

Figure 6.11 Core envelope

Key Return tag

The tag is labeled with the BEST address on the front and a number that identifies the employee who uses a particular key on the back. If this tag is found with a key, the key can be returned to BEST postage paid so that the finder cannot trace the key's origin.

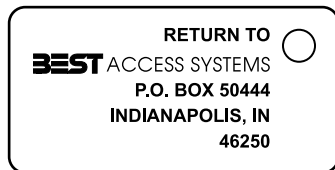

Figure 6.12 Key Return tag

Procedures to administer your key control system

The following actions are necessary to implement an effective key control program (adapt the following as needed for your facility).

- Obtain the appropriate cards and storage equipment, either by purchase from BEST or through local design.
- Inventory all locks throughout the facility that are in use, or should be used and list these locks by door number on a Door Number card. See [Figure 6.1 on page 6-7](#).
- Inventory all BEST cores in use at the facility and list the core numbers on the Core Number cards. See [Figure 6.2 on page 6-7](#).
- Inventory all keys that have been issued for the various locks, as well as spare keys on hand, and list them on the Key Marking card. See [Figure 6.3 on page 6-8](#).
- Compile a listing of all individuals holding keys to the building. Review this list thoroughly and reduce the number of key holders to an absolute minimum.
- Use the Employee Name card to record what keys are held by each employee with each of their signatures. See [Figure 6.4 on page 6-8](#).
- Store all key record cards in a lockable container, using dividers when needed.
- Store all unused keys and cores for future use:
 - ▲ Place each spare key and spare core in the appropriate envelopes.
 - ▲ Identify the key/core on the outside of the envelope.
 - ▲ Store all envelopes in a lockable container.

Sample key agreements

The Employee Name card (see [Figure 6.4 on page 6-8](#)) includes a blank section for written agreements that employees must agree to before receiving a key. For ideas of what might be printed in the “Agreement” section of an Employee Name card, see the examples listed below:

- I, the undersigned, hereby acknowledge receipt of the key/s described below. I promise and agree not to duplicate or have duplicated the key/s issued to me and to return it/them to the issuing office upon demand or when my need for said key/s no longer exists. I further agree that if said key/s is/are lost or otherwise not available for return, I will pay to the issuing office the sum of ____.
- I, the undersigned, hereby acknowledge receipt of the key/s described below, with the understanding that if I attempt to make duplicates, or loan this/these key/s to any other person, I, herewith, present myself to receive whatever punishment or disciplinary action the administration of this institution deems reasonable and just.
- I, the undersigned, by accepting the identified key/s, hereby agree to take diligent care and promptly report any loss thereof. I further agree to not give possession of said key/s to any other person nor cause or allow any copies to be made of such key. I understand that any violation of this agreement may result in termination of my employment with_____.

Issuing and returning keys

To issue a new key:

1. The employee submits a Key Request card. See [Figure 6.5](#) on [page 6-9](#).
2. Fill out an Employee Name card and file this alphabetically. See [Figure 6.4](#) on [page 6-8](#).
3. On a Key Marking card, indicate the following (see [Figure 6.3](#) on [page 6-8](#)):
 - key number
 - employee's name
 - date the key is issued.
4. The employee signs the Employee Name card which becomes, in effect, a contract.

When a key is returned:

1. Fill out a Key Receipt card and make a copy for your records. See [Figure 6.6](#) on [page 6-9](#).
2. Give the original copy to the employee in exchange for the key.
3. On the appropriate Key Marking card, strike out the employee's name and indicate the date that the key is returned. See [Figure 6.3](#) on [page 6-8](#).
4. On the appropriate Employee Name card , do the following (see [Figure 6.4](#) on [page 6-8](#)):
 - strike out the "key number" line
 - initial your changes and record the date
 - place this card in the inactive file if no other keys are currently signed out by this employee.
5. File the Key Receipt card copy.

Tips for managing your keys

- Send a test key to the factory or to your BEST Representative periodically for inspection.
- Destroy returned or worn keys but do not throw them in the trash.
- Replace master keys annually.
- Do not keep a file of your key cuts.
- Keep your control key in a secure location. Do not carry one with you.

When keys are lost or stolen

Guidelines for dealing with lost/stolen keys

It is important to be prepared when keys are lost or stolen. Follow the guidelines below.

- Establish a policy that requires employees to report missing keys immediately in person or by phone.
- Obtain BEST key trap cores for emergencies (see [page 4-3](#)).
- Attach Key Return tags to keys distributed to employees (see [page 6-12](#)).

Reporting lost or stolen keys

If an employee has lost a key or has had a key stolen from them, perform the following steps.

1. On a Lost Key Report card, record the employee's name and the date that the key was lost for the key control department. See [Figure 6.9](#) on [page 6-11](#).
2. Determine the security need for a relock (see [page 5-9](#)) or for installing a key trap core at the lost key location.
3. Take proper disciplinary actions against the appropriate employee if necessary and record proceedings.
4. On a Key Request card, record the employee's name and the date of the request for the key control department. See [Figure 6.5](#) on [page 6-9](#).

Adding, removing and changing cores

To add a new core:

1. Enter the door number at the top of a new Door Number card. See [Figure 6.1](#) on [page 6-7](#).
2. Enter the core number and date of installation.
3. Find the appropriate Core Number card (or start a new card if a new core number is used) and add the location of the newly installed core. See [Figure 6.2](#) on [page 6-7](#).

To remove a core:

1. Find the appropriate Door Number card and strike off the core number and date. See [Figure 6.1](#) on [page 6-7](#).
2. Enter "none" under "Core No." and specify the date of removal.
3. Find the appropriate Core Number card and strike out the line for core location. See [Figure 6.1](#) on [page 6-7](#).

To change a core:

1. Find the appropriate Door Number card and strike out the old core number and date. See [Figure 6.1](#) on [page 6-7](#).
2. Enter the new core number and date of installation.
3. Find the Core Number card that has the new core number and enter the following (see [Figure 6.2](#) on [page 6-7](#)):
 - location
 - date
 - door number.
4. Find the Core Number card for the old core. Strike out the entry name and then record the date of removal.

Tips for managing your cores

- Destroy all worn cores but do not throw them in the trash.
- Do not leave any barrels empty when loading the core.
- Do not keep a file of your pin segment order for combining cores.

Planning for emergencies

Setting aside extra codes

It is important to have extra codes set aside in the event that you need to change several or all of the locks in a particular area of your facility. For instance, if an employee's master key is lost or stolen, then the cores for the locks that the key has access to need to be recombined or replaced.

Having precombined cores available

In the event of an emergency where you need to replace a core, you may want to have precombined cores at your disposal for a quick and efficient changeover. You may need to replace only one particular core, but it is possible that you will need to replace several cores at once ([page 5-9](#)).

Emergency blackout blade

If no other measures can be taken, you can insert a keyway blackout blade into a core to prevent unauthorized entry ([page 4-3](#)). The blackout blade requires a special tool to remove it from the core. Contact your BEST Representative to order blackout blades and the removal tool.

PARTS SERVICING

For parts servicing, refer to the following manuals for your specific needs.

Instructions for	Refer to	
Replacing a dust cover assembly Lubricating a core Thawing a core Cleaning a core	<i>Core and Key Service Manual (T35527)</i>	
Replacing components on the key combinator: ■ punch and die ■ key carriage ■ operating lever Adjusting the key clamp spring Calibrating the key combinator Cleaning the key combinator Lubricating the key combinator		<i>Key Combinator Service Manual (T35532)</i>

GENERAL CORE MAINTENANCE

It is necessary to periodically clean and inspect your cores to ensure that they are functioning properly. Perform the following tasks as needed:

- Check for proper installation of any new cores
- Conduct periodic checks of the cores
 - ▲ operation of core in lockset
 - ▲ determine general wear
 - ▲ schedule a preventive maintenance plan
- Service and replace parts
- Lubricate cores according to your maintenance plan.

A

GLOSSARY

Calibrate	To check against a known standard and adjust to that standard.
Cap	Small piece of brass that is seated within a barrel, just below the surface of a core, to contain the segments and springs in each barrel.
Capping block	Small steel block used to hold a core while a cap is being seated within a barrel of the core.
Code	A number that specifies the cuts of a key that will properly operate a core (also relates to the combination of a core).
Combinating	Selecting a core's pin segments to match the key cuts.
Control key	A high-security key—unique for each BEST system—designed to remove and insert the figure-8 core.
Coremark	Sequence of letters and/or numbers that identifies a particular core.
Depth selector	Dial on a key combinator, marked with numbers, that is used for selecting key cut depths.
Ejector pin	Tool used to remove pin segments, springs, and caps from a core one barrel at a time.
Grandmaster key	Key that normally operates all locks in a masterkey system. However, a masterkey system might be designed so that the grandmaster key cannot operate selected locks such as cash boxes, hazardous waste areas, or drug cabinets.
Hand capping pin	Pin used to seat the cap within a barrel of a core.

Interchangeable core	Figure-8 shaped device that contains the main parts of a masterkey system. The interchangeable core can be removed by a special control key and can be recombined without disassembling the lock.
Key agreement	Document describing rules for a key issued to an employee and often signed by the employee. A key agreement might indicate how the employee should treat the key, when the key must be returned, and what the employee should do if the key is lost or stolen.
Key blade	Portion of a key that contains the keyway milling and key cuts.
Key blank	Key that has no key cuts.
Key carriage	Housing on a key combinator that moves the key to each keycut position.
Key combinator	Machine that cuts BEST key blanks for BEST masterkey systems.
Keycut depth	The distance from the bottom of the key cut to the underside of the key blade.
Keymark	Sequence of letters and numbers that indirectly corresponds to a keycut pattern for a key or group of keys that operates a particular core or lock.
Keystamp	Code number indicating the words stamped on all keys in a particular masterkey system. For example, "DO NOT DUPLICATE" or a company name can be keystamps.
Keyway	Cross-section shape milled into the key blank and broached into core plugs.
Keyway milling	Grooves machined into the length of the key blade to allow entry into the opening of a core.
Loading a core	Process of inserting segments, springs, and caps into each barrel of a core according to predetermined specifications.
Master key	Key that operates a large group of cores or locks, such as all locks in a building, on a floor, or for a department.
Masterkeying	Process of combining locks to allow a single key to operate many locks and at the same time allow each lock to be operated by a unique key.
Masterkey system	A complete hierarchical system provided by BEST Access Systems. A system normally consists of keymarks and coremarks that lets a single key operate many cores, and also lets each core be operated by its own key.
Multi-milling	Milling of a key to pass more than one keyway.
Operating key	Key that operates only one core or one group of keyed alike cores in a keying system.
Pin segment	Cylindrical-shaped part that fits into all barrels of a core. The sequence of pin segments varying in length inside a core permits a key to operate the core.

Punch and die	Part of the key combinator that notches keys to a precise shape.
Registered codes	Customized security codes assigned to a BEST Masterkey System. Only authorized personnel may receive these codes by registered mail.
Service equipment	Devices that allow a company to maintain and repair their own BEST Locking System. Service equipment includes key combinators, capping presses, and so forth.
Submaster key	Key that can unlock only specified groups of locks within a system.

B

INDEX

A

assessing an existing system 5-2

B

benefits of BEST masterkey system 2-2

C

capping block 3-4

cards

see key control system

code records 2-9

codes

obtaining 5-7

overview of 2-8

updating records for 6-5

combinating bin 3-4

combinating cores 6-2

combinating hammer 3-4

combinating kit 3-4

control key 2-6

core capping press 3-4

core dust cover 4-3

core envelope 6-12

core marking block 3-5

core marking plate 3-5

Core Number card 6-7

core stamping plate 3-5

cores

adding 6-15

changing 6-16

combinating 6-2

control of 2-10

installing 6-4

lubricating 3-5

options 4-3

overview of 2-6, 3-2

removing 6-15

servicing 6-17

stamping 6-3

tools for servicing 3-4

tools for stamping 3-5

cutting keys 6-3

D

designing a masterkey system 2-4

documentation package 1-2

Door Number card 6-7

drill resistant cores 4-3

E

ejector pin 3-4

emergencies 6-16

Employee Name card 6-8

extractor key 3-4

F

forms

see key control system

G

grandmaster key 2-6

graphite gun 3-5

G-Series forms 2-10

H

hand capping pin 3-4

I

installing cores 6-4

K

key combinator 3-4

key control system

administering 6-13

cards and equipment 6-6

developing 6-5

sample key agreements 6-13

key cut indicator 3-4

key envelope 6-11

key marking block 3-5

Key Marking card 6-8

key marking plate 3-5

Key Receipt card 6-9

Key Request card 6-9

key return tag 6-12

key stamping plate 3-5

keying schematic 5-4

keys

control of 2-10

control system for 6-5

cutting 6-3

issuing 6-14

overview of 2-6, 3-3

returning 6-14

stamping 6-3

tools for servicing 3-4

tools for stamping 3-5

types 2-6

updating records for 6-5

Keystone 600 2-10, 6-6

keytrap core 4-3

keyway blackout blade 3-4, 4-3,
6-16

keyways 2-7, 4-2

L

letter dies 3-5

Lock Request card 6-10

Lost Key Report card 6-11

LPS lubricant 3-5

lubricating cores 3-5

M

magnetic strip 3-5

master key 2-6

masterkey system

assessing changes to 5-2

BEST benefits 2-2

designing 2-4

determining size 2-8

heirarchy of 2-7

overview of 2-4

planning for emergencies 6-16

security for 2-9

N

number dies 3-5

O

operating key 2-6

P

patented keyways 2-7, 4-2

pick and drill resistant cores 4-3

pick resistant cores 4-3

pin size 2-8

product family diagram 2-5

R

re-locks 5-9

restricted keyways 2-7, 4-2

S

Safety Lock Opening Request card
6-10

schematic

see keying schematic

scrambled codes 4-3

security 2-9

site survey 5-2

stamping cores and keys 6-3

stamping tools 3-5

standard keyways 2-7, 4-2

submaster key 2-6

support, technical 1-2

survey

see site survey

T

technical documentation package
1-2

technical support 1-2

tools

for servicing cores and keys 3-
4

for stamping 3-5

lubrication items 3-5

tweezers 3-4

W

warranty 2-3

wear resistant cores 4-3