



9K Series

Heavy Duty Cylindrical Locks – Levers

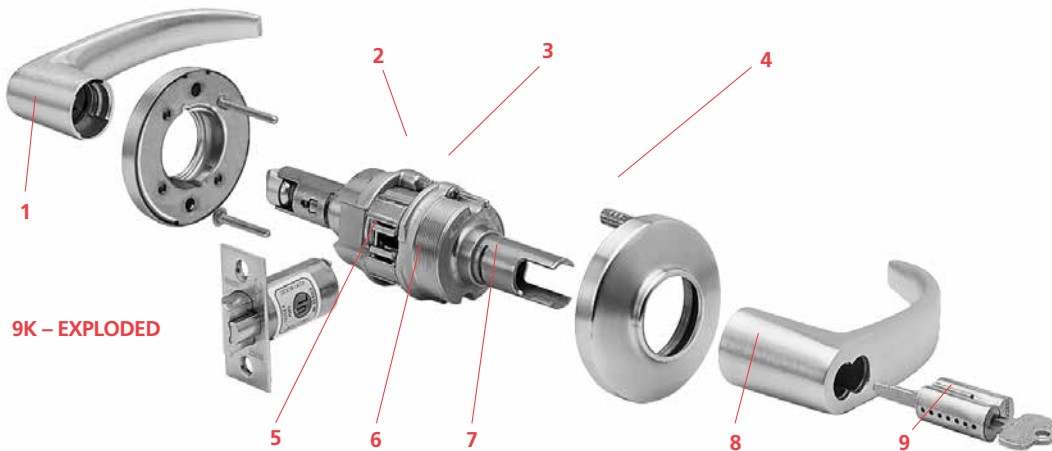

TABLE OF CONTENTS

Features	2	Deadlocking Latches & Strikes	10
Specifications	2-3	Lever Features & Dimensions	5
How to Order	3	Function	6-9
Shipping Weights	4	Strike & Door Preparation	11
Lever Styles & Trim	4	9K Sample Specifications	11
CORMAX™ Patented Keying System	10	Service Equipment	12

Features

1. For versatile applications, lever by knob trim variations are available.
2. Rose locking pin and rose assembly design offers great torque resistance. It prevents the locking pin from twisting, bending, or breaking under attack.
3. The innovative design of the slotted key release cam and locking lug assembly create maximum attack resistance. Even though damaged, the lock still allows key access. In addition, the lever is fully functional from the inside. The hub-mounted torsion spring and strong retractor springs help prevent lever sag and offer a smooth and snappy operation.
4. Strong through-bolt mounting studs increase torque resistance. Heavy rose liner material is highly attack resistant.
5. Strong retractor springs provide resistance to lever sag.
6. Zinc hubs with a shrouded locking lug, guaranteeing higher quality and increased torque resistance.
7. The outside lever sleeve is a seamless one piece construction made of a hardened steel alloy that provides additional reinforcement in the locking lug slot.
8. Lost Motion feature available allowing 45° lever rotation in either direction without engaging retractor assembly.
9. Interchangeable core allows for quick re-keying and customized masterkeying.



Specifications

ADA—Americans With Disabilities Act: 9K series – The design and operation of the BEST® cylindrical lock meets the intent of the standard for ANSI A117.1 section 404.2.6

Builders Hardware Manufacturers Association: 9K series – Listed by BHMA for A156.2, Series 4000, Grade 1.

Underwriters Laboratories®: 9K series – Listed by Underwriters Laboratories for use on 3 Hr, A label for single or double swinging doors.

Florida Building Code and Miami-Dade County Code: 9K series – 9/16" latch throw – Listed by Florida Building Code and Miami-Dade County at ± 75 PSF for single doors. 9K series – 3/4" latch throw – Listed by Florida Building Code and Miami Dade County at ± 80 PSF for single doors and ± 50 PSF for double doors.

"WS" option must be ordered for the lock to include a "Miami-Dade County Product Control Approved" label for inspection purposes.

California State Fire Marshal: 9K series – Listed with California State Fire Marshal.

9K series 14 & 15 lever conforms with California Title 24.





Backset – 2 3/4" standard, 3 3/4" and 5" available.

Chassis – Critical latch and chassis components are brass or corrosion-treated steel. 2 1/16" diameter to fit 2 1/8" hole in door (Conforms to ANSI A115.2). Lost Motion feature available as an option. (see page 5 for options/features).

Door thickness – Available for 1 3/4" to 2 1/4" doors only. Spacers available for 1 3/8" doors.

Roses – C – 3" Convex, D – 3 1/2" Convex, K – 3" Convex-no ring, L – 3 1/2" Convex-no ring

Products protected by one or more of the following patents – 5,590,555 5,794,472 Other products patent pending.

Finishes –

(BHMA) US	DESCRIPTION	(BHMA) US	DESCRIPTION	(BHMA) US	DESCRIPTION
605 3	bright brass	613 10B	oxidized satin bronze, oil rubbed	622 19	flat black
606 4	satin brass	618 14	bright nickel plated	625 26	bright chromium plated
611 9	bright bronze	619 15	satin nickel plated	626 26D	satin chromium plated
612 10	satin bronze			690 20	dark bronze

Antimicrobial Finish – 626AM satin chrome plated with UltraShield™ antimicrobial protected coating



The BEST UltraShield™ finish inhibits the growth of bacteria and other microbes on the surface of the hardware.

NOTE: BEST's UltraShield™ option is recommended for use on any hardware application where product cleanliness is a high priority. i.e.: Hospital/Healthcare, Elderly Care, Education, Transportation, Food-Service, Hospitality.

Latch – Solid brass 9/16" throw. Front 2 1/4" x 1 1/8" beveled.

Lever handles – Lever handles are a high-quality zinc alloy. Trim components are brass or bronze. Body is approximately 5/8" in diameter; Handle is approximately 4 3/4" long (from center-line of chassis). #14 and #15 levers conform to California Administrative Code Title 19 and Title 24. All three styles of levers conform to the Illinois Accessibility Standard.

Mounting – In addition to standard door preparation (ANSI A115.2 for 1 3/4" doors), two additional holes are needed for through-bolts. Through-bolts require two 5/16" diameter holes located at 12 o'clock and 6 o'clock positions. A drill jig can be ordered to insure accuracy of the holes. (see KD303 page 5).

Projection on door – Approx. 2 3/4" when mounted on 1 3/4" door.

Strike – STK: Conforms to ANSI A115.2 (2 3/4" x 1 1/8" with curved lip & box). S3: Conforms to ANSI A115.2 for 1 3/4" doors (4 7/8" x 1 1/4" with curved lip). S3-7/8: Conforms to ANSI A115.2 for 1 1/4" doors (4 7/8" x 1 7/8" flat)

How to Order

9K	3	7	AB	15	A	STK	626	
Series	Backset	Core Housing	Function Code	Lever	Rose Style	Strike Package	Standard Finishes	Options
9K	3 – 2 3/4" 4 – 3 3/4" 5 – 5"	0– keyless 7– 7-pin housing accepts all BEST® cores	AB– entrance D– storeroom L– privacy N– passage R– classroom etc.	♿14– curved return ♿15– contour angle return ♿16– curved no return	C– 3" convex D– 3 1/2" convex K– 3" convex - no ring L– 3 1/2" convex - no ring	STK– 2 3/4" ANSI S3– 4 7/8" ANSI S3– 7/8- 7/8" flat strike	605 606 611 612 613 618 619 622 625 626 690	AL– abrasive lever LL– lead lined LM– lost motion RQE– request to exit** SH– security head screws TL– tactile lever 3/4– 3/4" throw latch 7/8" LTC– flat lip strike NOTE: specify inside (I), outside (O), or both (B) for AL,TL options
			pages 6-9	pages 4-5	pages 4-5	page 11		page 5

*Handles are made from a zinc alloy, and have been plated to be equivalent in appearance to the finishes listed.

For information on 9K non-IC products please refer to BEST's non-IC keying products brochure.

**RQE option requires modification to chassis and is sold with assembly unit only.

Shipping Weights

The chart is the approximate shipping weight for the standard 9K functions locksets. This weight includes the weight of the lockset with the “#15” style lever, “K” style rose, latch, strike package, and box. Listed separately are the approximate weights for “with core” and “less core” shipments.

Lock Function Nomenclature	Case Quantity	Shipping Weight With Core	Shipping Weight Less Core
Y	9		31 lbs
N	9		40 lbs.
L,NX,P	9		40 lbs.
AB,D,E,H,HJ,R,T	9	42 lbs.	40 lbs.
C,G,IN,S,W	9	44 lbs.	40 lbs.

Lever Styles and Trim

#14C 



#15C 



#16C 



#14D 



#15D 



#16D 



#14K 



#15K 



#16K 



#14L 



#15L 



#16L 



Lever Features

Abrasive Lever Option

Besides complying with a wide variety of accessibility codes and ordinances, BEST lever handles are available with a special abrasive feature. Abrasive strip on the lever immediately identifies warnings on doors to hazardous areas for the blind.

To order: Designate **"AL"** on How to Order (page 3). Note: abrasive strip is available on all levers, except #14, #15, #16 levers in 613 finish.

Lost Motion Feature

The Lost Motion feature allows the lever handle to move 45 degrees from parallel to the horizontal plane without engaging the latchbolt assembly. When the lockset is in the locked mode, this feature makes over-torque or over-lever-age abuse more difficult to achieve. **To order:** designate **"LM"** on How to Order (page 3).

Non IC Lever Option

The 9K heavy duty cylindrical lock may be adapted to existing keying systems by using a special retrofit lever and throw member that will accept 6 pin single shear-line cylinders from non BEST manufacturers. No internal modifications are required to adapt the 9K to cylinders from the following manufacturers: Corbin-Russwin, Medeco, Sargent, Schlage, Yale. Refer to BEST® non-IC keying products brochure for more details.

RQE Feature

The 9K lever handle cylindrical can be built to incorporate a request-to-exit (RQE) switch. A normally open switch provides momentary switch closure when the inside lever is rotated. RQE option requires modification to chassis and is sold with assembly unit only.

To order: designate **"RQE"** on How to Order (page 3).

Tactile Lever Option

Tactile levers may be used in areas where improved grip is required or as a warning in hazardous areas. Grooves are machined into the back of the hand grasp portion of the lever to improve grip and/or to provide a sensory warning in hazardous areas. This option can be used for Blind, Safety or Accessibility applications. **To order:** Designate **"TL"** on How to Order (page 3).

Lever & Trim Dimensions

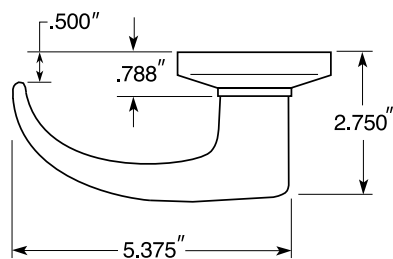
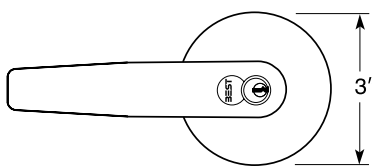



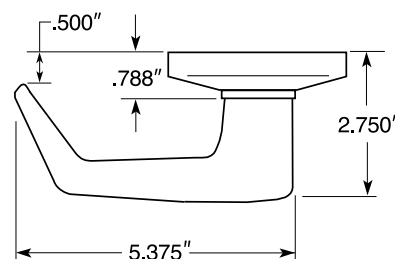
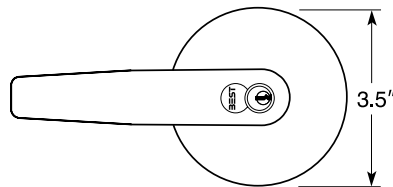



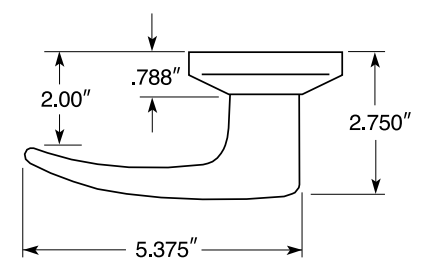
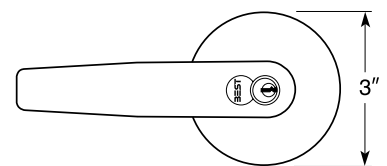

#14C or #14K Trim
("C" rose shown)



#15D or #15L Trim
("D" rose shown)







#16C or #16K Trim
("K" rose shown)

	Description	Outside Lever		Inside Lever	
Function & Diag. (ANSI No.)	Latch operated by	Locked by	Unlocked by	Locked by	Unlocked by
Single keyed					
Entrance (AB) F109 	<ul style="list-style-type: none"> Rotating the inside lever, Rotating the outside lever—only when the inside push button is out, Turning the key in the outside lever 	<ul style="list-style-type: none"> Pushing the inside button, Pushing and turning the inside button. Turning the button keeps the outside lever locked until the button is turned back 	<ul style="list-style-type: none"> Turning the key in the outside lever, (only when the button is not turned) Rotating the inside lever, (only when the button is not turned). Closing the door (only when the button is not turned) 	Cannot be locked	Always unlocked
Storeroom (D) F86 	<ul style="list-style-type: none"> Turning the key in the outside lever, Rotating the inside lever 	Always fixed	Cannot be unlocked	Cannot be locked	Always unlocked
Service Station (E) F92 	<ul style="list-style-type: none"> Rotating the inside lever, Rotating the outside lever—only when the inside push button is out. Turning the key in the outside lever 	<ul style="list-style-type: none"> Pushing the inside button, Pushing and turning the inside button. Turning the button keeps the outside lever locked until the button is turned back 	<ul style="list-style-type: none"> Turning the key in the outside lever, Rotating the inside lever, Closing the door—only when the button is not turned, Turning back the slotted button 	Cannot be locked	Always unlocked
Hotel Guest Room (H) F93  (Indicator Included)	<ul style="list-style-type: none"> Rotating the inside lever, Turning the key in the outside lever—only when the inside push button is out, Removing the core with a control key and using a special emergency key 	Always fixed	Key block feature is released by: <ul style="list-style-type: none"> Rotating the inside lever, Closing the door 	Cannot be locked	Always unlocked
Pushing the inside button projects an “occupied” indicator in the outside lever and blocks all operating keys.					
Hotel Guest Room (HJ)  (No Indicator)	<ul style="list-style-type: none"> Rotating the inside lever, Turning the key in the outside lever—only when the inside push button is out, Removing the core with a control key and using a special emergency key 	Always fixed	Key block feature is released by: <ul style="list-style-type: none"> Rotating the inside lever, Closing the door 	Cannot be locked	Always unlocked
Pushing the inside button blocks all operating keys, but no “occupied” indicator is projected.					
Classroom (R) F84 	<ul style="list-style-type: none"> Rotating the inside lever, Turning the key in the outside lever, Rotating the outside lever when not locked by key 	Turning the key in the outside lever,	Turning the key in the outside lever,	Cannot be locked	Always unlocked
Dormitory (T) F90 	<ul style="list-style-type: none"> Rotating the inside lever, Rotating the outside lever when not locked by key or push button 	<ul style="list-style-type: none"> Turning the key in the outside lever, Pushing the button on the inside lever 	<ul style="list-style-type: none"> Turning the key in the outside lever, Rotating the inside lever (only when locked by push button), Closing the door (only when locked by push button) 	Cannot be locked	Always unlocked
Entrance/Office (UA) 	<ul style="list-style-type: none"> Rotating the inside lever, Rotating the outside lever—only when the inside push button is out, Turning the key in the outside lever 	<ul style="list-style-type: none"> Pushing the inside button, Pushing and turning the inside button. Turning the button keeps the outside lever locked until the button is turned back 	<ul style="list-style-type: none"> Turning the key in the outside lever, (only when the button is not turned) Rotating the inside lever, (only when the button is not turned). 	Cannot be locked	Always unlocked
Double keyed					
Corridor (C) F88 	<ul style="list-style-type: none"> Rotating the inside lever, Rotating the outside lever when not locked by key, Turning the key in the outside lever 	Turning the key in the inside lever	Turning the key in the inside lever	Cannot be locked	Always unlocked

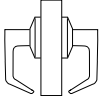

*ATTENTION: Locksets that secure both sides of the door are controlled by building codes and the Life Safety Code. In an emergency exit situation, failure to quickly unlock the inside lever could be hazardous or even fatal.

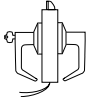
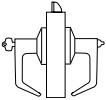
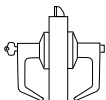
Function & Diag. (ANSI No.)	Description	Outside Lever		Inside Lever	
		Latched operated by	Locked by	Unlocked by	Locked by
Double keyed (Continued)					
Storeroom* (G) F91 	<ul style="list-style-type: none"> Rotating the outside lever when not locked by key, Rotating the inside lever when not locked by key 	<ul style="list-style-type: none"> Turning the key in the inside lever, Turning the key in the outside lever 	<ul style="list-style-type: none"> Turning the key in the inside lever, Turning the key in the outside lever 	<ul style="list-style-type: none"> Turning the key in the inside lever, Turning the key in the outside lever 	<ul style="list-style-type: none"> Turning the key in the inside lever, Turning the key in the outside lever
Turning the key in either the inside or the outside, locks or unlocks both sides.					
Intruder (IN) F11 	<ul style="list-style-type: none"> Rotating inside lever, Rotating outside lever only when not locked by inside or outside key 	<ul style="list-style-type: none"> Turning key in the inside lever, Turning the key in the outside lever 	<ul style="list-style-type: none"> Turning key in the inside lever, Turning the key in the outside lever 	Cannot be locked	Always unlocked
Communicating* (S) F80 	<ul style="list-style-type: none"> Turning the key in the inside lever, Turning the key in the outside lever, Rotating the inside or outside lever (if unlocked) 	Turning the key in the outside lever	Turning the key in the outside lever	Turning the key in the inside lever	Turning the key in the inside lever
Turning the key in either lever, locks or unlocks its own lever independently..					
Communicating* (W) F87 	<ul style="list-style-type: none"> Turning the key in the inside lever, Turning the key in the outside lever 	Always fixed	Cannot be unlocked	Always fixed	Cannot be unlocked
Keyless					
Privacy (L) F76 	<ul style="list-style-type: none"> Rotating the inside lever Rotating the outside lever only when the inside push button is out 	Pushing the inside button	<ul style="list-style-type: none"> Rotating the outside slotted button, Rotating the inside lever, Closing the door. 	Cannot be locked	Always unlocked
Passage (N) F75 	<ul style="list-style-type: none"> Rotating the inside lever, Rotating the outside lever 	Cannot be locked	Always unlocked	Cannot be locked	Always unlocked
Exit (NX) F89 	Rotating the inside lever	Always fixed	Always fixed	Cannot be locked	Always unlocked
Patio (P) F77 	<ul style="list-style-type: none"> Rotating the inside lever, Rotating the outside lever only when the inside push button is out 	Pushing the inside button	<ul style="list-style-type: none"> Rotating the inside lever, Closing the door 	Cannot be locked	Always unlocked
Exit (Y) 	Rotating the inside lever			Cannot be locked	Always unlocked
Single Dummy Trim (1DT) 	This is a single, surface-mounted lever for an inactive door or a non-latching door				

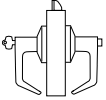
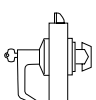
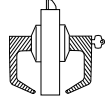
*ATTENTION: Locksets that secure both sides of the door are controlled by building codes and the Life Safety Code. In an emergency exit situation, failure to quickly unlock the inside lever could be hazardous or even fatal.

	Description	Outside Lever		Inside Lever	
Function & Diag. (ANSI No.)	Latch operated by	Locked by	Unlocked by	Locked by	Unlocked by
Keyless (Continued)					
Double Dummy Trim (2DT) 	This is a through bolt mounted pair of matching levers for an inactive door or a non-latching door				
Electromechanical					
Electrically Locked (DEL) 	<ul style="list-style-type: none"> Rotating the inside lever, Rotating the outside lever only when power is off, Turning the key in the outside lever 	<ul style="list-style-type: none"> Applying 24 Volts DC. Outside lever remains locked only while power is on 	Switching off 24 Volts DC	Cannot be locked	Always unlocked
Electrically Unlocked (DEU) 	<ul style="list-style-type: none"> Rotating the inside lever, Rotating the outside lever only when power is on, Turning the key in the outside lever 	Switching off 24 Volts DC	<ul style="list-style-type: none"> Applying 24 Volts DC Outside lever remains unlocked only while power is on 	Cannot be locked	Always unlocked
Special					
Dormitory or Storeroom (A) F81 	<ul style="list-style-type: none"> Rotating the inside lever, Rotating the outside lever only when inside turn button is in unlocked position, Turning the key in the outside lever 	Turning the inside button	Turning the inside button	Cannot be locked	Always unlocked
NOTE: Turn button must be manually rotated to unlock the outside lever.					
Office (B) F82 	<ul style="list-style-type: none"> Rotating the inside lever, Rotating the outside lever only when inside push button is out, Turning the key in the outside lever 	Pushing the inside button		Cannot be locked	Always unlocked
NOTE: Push button is released by turning the key in the outside lever, OR rotating the inside lever. Closing the door does not release the push button.					
Closet or Storeroom (DZ) 	<ul style="list-style-type: none"> Turning the key in the outside lever, Turning the inside closet turn knob 	Always fixed	Cannot be unlocked	Closet turn knob cannot be locked	Closet turn knob cannot be locked
Entrance or Office (EA) 	<ul style="list-style-type: none"> Rotating the inside lever, Rotating the outside lever only when inside push button is out, Turning the key in the outside lever 	<ul style="list-style-type: none"> Pushing the inside button, Pushing and turning the inside button. Turning the slotted button keeps the outside lever locked until the button is turned back 	<ul style="list-style-type: none"> Turning the key in the outside lever, Rotating the inside lever, Turning the slotted button back 	Cannot be locked	Always unlocked
Closet or Storeroom (RZ) 	<ul style="list-style-type: none"> Turning the key in the outside lever, Turning the inside closet turn knob, Rotating the outside lever when not locked by key 	Turning the key in the outside lever	Turning the key in the outside lever	Closet turn knob cannot be locked	Closet turn knob always free
Special* (XD) 	Turning the key in the inside lever	Always fixed	Cannot be unlocked	Always fixed	Cannot be unlocked

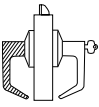
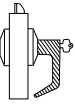
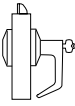
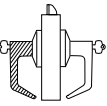
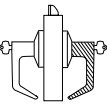
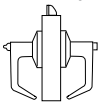
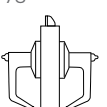
*ATTENTION: Locksets that secure both sides of the door are controlled by building codes and the Life Safety Code. In an emergency exit situation, failure to quickly unlock the inside lever could be hazardous or even fatal.

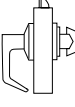
Function & Diag. (ANSI No.)	Description	Outside Lever		Inside Lever	
		Latched operated by	Locked by	Unlocked by	Locked by
Special (Continued)					
Special* (XR) 	<ul style="list-style-type: none"> Turning the key in the inside lever, Rotating the inside lever when not locked by key 	Always fixed	Cannot be unlocked	Turning the key in the inside lever	Turning the key in the inside lever
Exit *(YD) 	Turning the key in the inside lever			Always fixed	Cannot be unlocked
Special *(YR) 	<ul style="list-style-type: none"> Turning the key in the inside lever, Rotating the inside lever when not locked by key 			Turning the key in the inside lever	Turning the key in the inside lever
Special *(DR) 	<ul style="list-style-type: none"> Rotating the inside lever only when not locked by key, Turning the key in the outside lever, Turning the key in the inside lever 	Always fixed	Cannot be unlocked	Turning the key in the inside lever	Turning the key in the inside lever
Special *(RD) 	<ul style="list-style-type: none"> Rotating the outside lever only when not locked by key, Turning the key in the outside lever, Turning the key in the inside lever 	Turning the key in the outside lever	Turning the key in the outside lever	Always fixed	Cannot be unlocked
Hospital Privacy (LL) 	<ul style="list-style-type: none"> Rotating the inside lever, Rotating the outside lever only when the inside push button is out 	Pushing the inside push button	<ul style="list-style-type: none"> Turning the turn button in the outside lever, Rotating the inside lever, Closing the door 	Cannot be locked	Always unlocked
Communicating* (M) F78 	<ul style="list-style-type: none"> Rotating the inside lever-only when the outside turn button is in the unlocked position, Rotating the outside lever-only when the inside turn button is in the unlocked position 	Turning the inside turn button	Turning the inside turn button	Turning the outside turn button	Turning the outside turn button
NOTE: Do not use this function for rooms that have no other entrance.					
Exit (Q) F83 	<ul style="list-style-type: none"> Rotating the inside lever, Rotating the outside lever-only when the inside turn button is in the unlocked position 	Turning the inside turn button	Turning the inside turn button	Cannot be locked	Always unlocked
Closet (Z) 	<ul style="list-style-type: none"> Rotating the outside lever, Turning the inside closet turn knob 	Cannot be locked	Always unlocked	Closet turn knob cannot be locked	Closet turn knob is always free

*ATTENTION: Locksets that secure both sides of the door are controlled by building codes and the Life Safety Code. In an emergency exit situation, failure to quickly unlock the inside lever could be hazardous or even fatal.

CORMAX™ Patented Keying System

BEST® CORMAX™ is the premier patented keying system offered by BEST. CORMAX will meet your needs for security, key control, and convenience. A simple solution with no compromising allowed.

CORMAX is the upgrade path for existing BEST Standard, Premium, and MX8 customers; and it is an essential element of non-residential access control as security administrators strive to eliminate the unauthorized duplication of keys.



**CORMAX™
Patented Keying System**

CORMAX offers the following features and benefits:

- A long-term US utility patent that guarantees the extended useful life of the system through 2027.
- A second, independent locking mechanism that utilizes a patented set of built-in side pins to provide higher security.
- Several levels of geographical exclusivity, including national exclusivity, are available via the patented side pin feature.
- CORMAX cores and keys are available exclusively through BEST sales offices. Key blanks are only sold to individuals authorized by the customer to ensure key blanks do not end up in the possession of unauthorized personnel either inside or outside the customer's facility.
- CORMAX cores are certified to meet the security, safety, and reliability requirements of BHMA A156.5 Grade 1.
- Picking and drilling resistance options are available if higher levels of security are desired.
- Complete factory masterkeying service offered, and at no charge with purchase of BEST locksets and PHI exit devices.
- Keyways are organized in families of four keyways each, with double-milled and quad-milled key levels to facilitate the design of masterkey systems in multi-building campuses.
- BEST CORMAX cores are compatible with all existing BEST interchangeable core housings, eliminating the need for new or modified locksets.

Deadlocking Latches & Strikes



8KL3 Deadlocking Latch

Bolt throw – 9/16"

Backset – 2 3/4"

Front – 2 1/4" x 1 1/8" beveled.

Tube – To fit 1" diameter hole in door edge.

To order: (with unit) designate "9K3" on How to Order (page 3).

To order: (without unit) designate "8KL3-SL" (Spring Latch) or DL (Deadlocking Latch) and finish.



8KS3-7/8 Flat Strike

Dimension: Conforms to ANSI A115.2 for 1 3/4" doors (4 7/8" x 1 7/8" flat)

To order: (with unit) designate "S3-7/8" on How to Order (page 3).

To order: (without unit) designate 8KS3-7/8 and finish.



8KL4 Deadlocking Latch

Bolt throw – 9/16"

Backset – 3 3/4"

Front – 2 1/4" x 1 1/8" beveled.

Tube – To fit 1" diameter hole in door edge.

To order: (with unit) designate "9K4" on How to Order (page 3).

To order: (without unit) designate "8KL4-SL" (Spring Latch) or DL (Deadlocking Latch) and finish.



8KS3 Strike

Dimension: Conforms to ANSI A115.2 for 1 3/4" doors (4 7/8" x 1 1/4" with curved lip).

To order: (with unit) designate "S3" on How to Order (page 3).

To order: (without unit) designate 8KS3 and finish.



8KL5 Deadlocking Latch

Bolt throw – 9/16"

Backset – 5"

Front – 2 1/4" x 1 1/8" beveled.

Tube – To fit 1" diameter hole in door edge.

To order: (with unit) designate "9K5" on How to Order (page 3).

To order: (without unit) designate "8KL5-SL" (Spring Latch) or DL (Deadlocking Latch) and finish.



8KS2 Strike (Supplied Standard)

Dimension: Conforms to ANSI A115.2 for 1 3/8" doors (2 3/4" x 1 1/8" with curved lip and box).

To order: (with unit) designate "STK" on How to Order (page 3).

To order: (without unit) designate 8KS2 and finish.

Strikes & Door Preparation

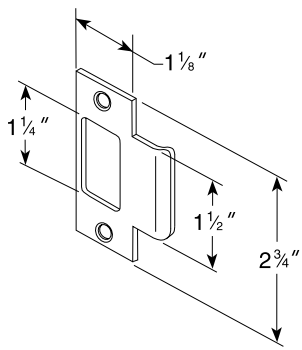

STK strike (standard)

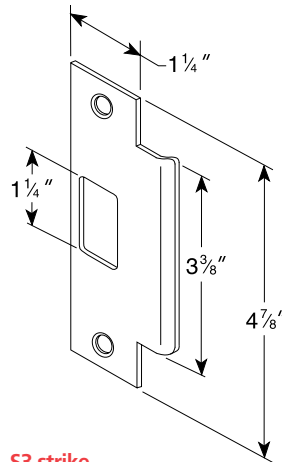

S3 strike

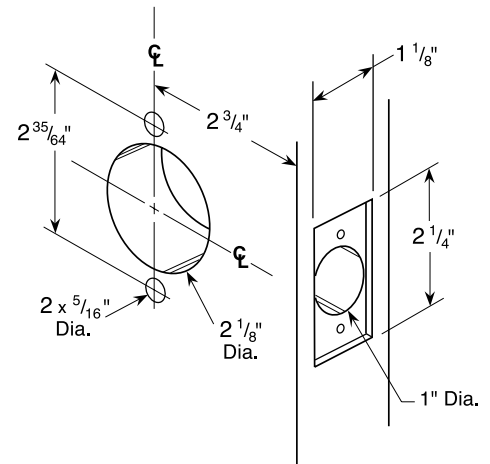

9K door preparation with through-bolt mountings

Sample Specification Acceptable Manufacturers

A. Locksets and Latchsets

BEST - No Substitution.

1. Locksets and latchsets: ANSI A156.2, Series 4000, Grade 1 UL listed, extra heavy-duty cylindrical type.
2. Backset 2 3/4 inches (70mm)
3. Interchangeable core 7-pin: [Restricted keyway] [Patented] [Standard] [_____].
4. Locksets to have anti-rotational studs that are through-bolted.
5. Keyed lever with no exposed keeper hole.
6. Each lever to have independent spring mechanism designed to control lever only.
7. Outside lever sleeve seamless, 1-piece construction, hardened steel alloy.
8. Keyed Lever: Removable only after core is removed, by authorized control key, to allow access to knob keeper
9. Hub, side plate, anti-rotational studs 1-piece casting with shrouded locking lug.

B. Keys and Keying

A. Cylinders: 7-pin, interchangeable core and keyed into a [New] [Existing] factory registered Grand Masterkey System with a [Standard] [Restricted] [Patented] keyway.

1. Acceptable Material: Cylinders as manufactured by BEST.

B. Provide construction cores and keys during construction period. Construction control and operating keys and cores are not part of permanent keying system or furnished on same keyway (or key section) as permanent keying system.

C. Permanent Keys and Cores: Prepare permanent cores and keys in accordance with keying schedule. [Stamp with applicable key mark for identification.] [Do not stamp.] [_____].

D. Provide Grand Masterkeys, Masterkeys and other Security Keys.

E. Furnish keys in the following quantities:

1. [4] [_____] each Grand Masterkeys.
2. [4] [_____] each Masterkeys per set.
3. [2] [_____] each Change keys each keyed core.
4. [6] [_____] each Construction masterkeys.
5. [2] [_____] each Control keys.
6. Install permanent cores in locksets.

F. Return construction cores to [{BEST} factory representative] [Hardware manufacturer's representative].

Service Equipment

KD304A Boring Jig Kit

The KD304A jig kit is made for boring cut-outs in wooden doors for Fed. Spec. 160 and 161 series cylindrical/tubular locksets, doors 1 3/8" to 2 1/4" thick. The KD304A kit includes the boring jig (to drill wood doors for 2 3/8", 2 3/4", 3 3/4", and 5" backsets), a quick-release adaptor for 3/8" drill chuck, a 2 1/8" bit, and a 1" diameter x 9" bit.

The following kit items can also be purchased separately.

KD309 – 2 1/8" bit

KD318 – 1" dia. x 9" bit

KD319 – 3/8", quick release adaptor

To order complete kits specify:

KD304A Kit

KD312 and KD315 Face Plate Marking Chisel and KD325 Strike Plate Location Pin

The KD315 face plate marking chisel (which locates the mortising for the faceplate) and the KD325 strike locating pin (which centers the strike for proper installation) and is used for Fed. Spec. 161 cylindrical lockset, (1 1/8" x 2 1/4"), and BEST® series 82T & 83T tubular locks. The KD312 face plate marking chisel is available for Fed. Spec. 160 (1" x 2 1/4") preparation

To order specify:

KD312– face plate marking chisel 1" (160)

KD315– face plate marking chisel 1 1/8" (161)

KD325– strike plate locating pin

KD303 Through-Bolt Drill Jig

Special accessory jig aids in aligning 5/16" holes for through-bolt mounting. Install the latch first, then insert jig in 2 1/8" bored hole, align with door edge and drill with 5/16" drill bit. **To order specify: KD303.**

KD317 Spanner Wrench and KD340 Spring Tool

All 9K locksets require the use of KD317 spanner wrench for door removal. This tool is included 1 per every 9 locksets with your order. If more are needed, desnate KD317 on your order. The KD340 lever return spring tool with its unique design feature is used when replacing the 9K lever return spring. **To order specify: KD340.**



KD304A parts



KD304A with case



KD315
(Fed. Spec. 161)



KD325



KD303-9K



KD317
Spanner Wrench



KD340
Spring Tool



6161 East 75th Street
Indianapolis, IN 46250 USA

Phone 855-365-2407

bestaccess.com