

BEST 
dormakaba Group



T Series

Tubular Deadbolts
by BEST

BEST: Setting the Standard for Security

Deadbolt Features



1. No exposed mounting screws standard on 8T2/8T3 double cylinder M function only (available as an option on 8T2/8T3 K, L, and S function)
2. Full 1" stainless steel throw deadbolt
3. Free-turning, wrench-resistant, tapered cylinder ring
4. 8T2/8T3-solid extruded brass or bronze cylinder 7T2/7T3-solid cast zinc with brass or bronze shell
5. Stainless steel for strength and corrosion resistance
6. Simple installation; self-aligning and reversible strike
7. May be keyed into existing BEST® masterkeyed system
8. The original interchangeable core permits instant, economical rekeying
9. ADA turn lever
10. Deadbolt UL listed for use as auxiliary lock type on 3 hr. fire doors (GWXT). These locks also carry the C-UL mark which is officially accepted in all of Canada, indicating compliance with appropriate Canadian standards and codes.

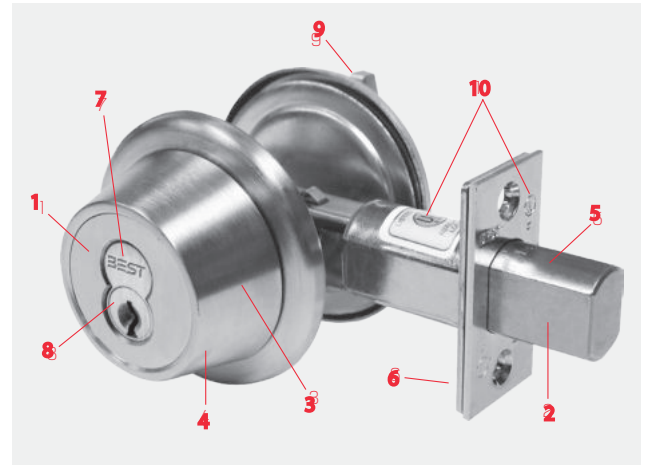

Products protected by one or more of the following patents: 4,301,667 D290,085 4,843,852 5,590,555 5,794,472 Other Patents Pending

Specifications

Backset – 7T2/8T2: 2-3/8", 7T3/8T3: 2-3/4"

Cylinders – 8T2/8T3: ANSI A156.36-2010 Auxiliary Locks, Grade 1 Operational, BHMA, Strength and Security with drill-resistant core (ICD/ICDP/ICDB/ICDF/ICDM/ICDX)
7T2/7T3: ANSI A156.36-2010 Auxiliary Locks, Grade 2 Operational, BHMA, Strength and Security with drill-resistant core (ICD/ICDP/ICDB/ICDF/ICDM/ICDX)

Deadbolt – 7T2/7T3: 1" throw, 5/8" x 7/8" bolt. Brass nickel plated, with concealed hardened steel free-turning pin. Housing fits 1" bore. 8T2/8T3: 1" throw, 5/8" x 7/8" solid stainless steel bolt. Housing fits 1" bore.

Door thickness – Fits 1-3/4" doors (standard), 7T2/7T3: fits doors - from 1-3/8" to 2-1/8", 8T2/8T3: fits doors - from 1-3/8" to 3". Specify if other than 1-3/4"

Faceplate – Brass or bronze base material. 7T2/8T2: 1" x 2-1/4", 7T3/8T3: 1-1/8" x 2-1/4"

Finishes –

- 7T2/7T3:
- 612 – satin bronze
 - 626 – satin chromium
- 8T2/8T3:
- 605 – bright brass
 - 606 – satin brass
 - 611 – bright bronze
 - 612 – satin bronze
 - 613 – dark oxidized satin
 - 625 – bright chromium
 - 626 – satin chromium

Strikes – 8TSTK: Rectangular 1-1/8" x 2-3/4" (ANSI A156.36-2010)
8TS1: Curved lip 1-1/4" x 4-7/8" (ANSI A156.36-2010)
8TS4: Curved lip 1-1/8" x 2-3/4" (ANSI A156.36-2010)
8TS5: High security rectangular 1-1/4" x 4-7/8" (ANSI A156.36-2010)

Trim – Wrought brass or bronze cylinder rose or turn lever rose, 2- 3/4" dia. to cover 2-1/8" bore. Machined brass or bronze cylinder ring.

Strikes

8TSTK Standard Strike

Dimensions: 1-1/8" x 2-3/4"
(Supplied with box and screws)

To order: (with unit) STK
To order: (without unit) 8TSTK and finish



8TS4 Strike

Dimensions: 1-1/8" x 2-3/4" with curved lip
(Supplied with box and screws)

To order: (with unit) S4
To order: (without unit) 8TS4 and finish



8TS1 Strike

Dimensions: 1-1/4" x 4-7/8" (ANSI 115.1)
(Supplied with box and screws)

To order: (with unit) S1
To order: (without unit) 8TS1 and finish



8TS5 High Security Strike

Dimensions: 1-1/4" x 4-7/8"
(Supplied with box and long screws)

To order: (with unit) S5
To order: (without unit) 8TS5 and 630 finish ONLY

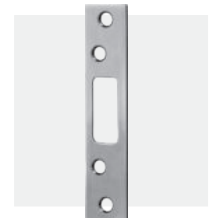

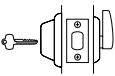
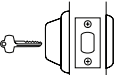

Functions

Function & Diag. ANSI No. (Fed. NO.)	Deadbolt operated by
K-Turnknob E2151, E2152 (181K) 	Turning the key in the outside cylinder Turning the inside turn lever.
L-One-Way Deadbolt E2161, E2162 (181L) 	Turning the key in the outside cylinder; the inside cylinder is blank

*ATTENTION: Locksets that secure both sides of the door are controlled by building codes and the Life Safety Code. In an emergency exit situation, failure to quickly unlock the deadbolt could be hazardous or even fatal.

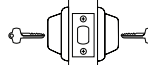
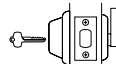
Functions

Function & Diag. ANSI No.(Fed. NO.)	Deadbolt operated by
*M-Double Cylinder E2141, E2142 (181M) 	Turning the key in the inside or outside cylinder The inside mounting screws are concealed
S-Classroom One-Way Deadbolt E2171 (181S) 	Turning the key in the outside cylinder Turning the inside turn lever only retracts the deadbolt (available ONLY in 82T/83T) NOTE: Can't throw the deadbolt.
KL-Closet (Available only in 82T/83T) 	Turning the turn lever only

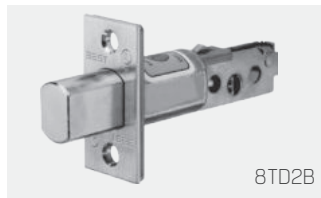

8TD2B

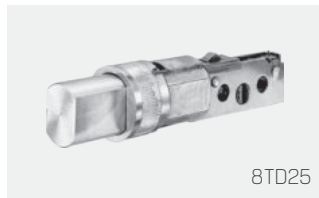

8TD25



8TD3B

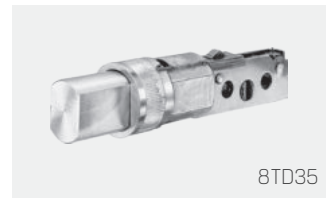

8TD35

8T2/8T3 Tube Assemblies

8TD2B Deadbolt Tube Assembly

Bolt throw: 1"

Backset: 2-3/8"

Faceplate: brass or bronze, 1" x 2-1/4". self-adjusting and reversible for either door hand.

Tube: steel, fits 1" diameter bore.

To order without trim: 82TDB and finish

8TD25 Drive-in Bolt Tube Assembly

Bolt throw: 1"

Backset: 2-3/8"

Faceplate: brass or bronze, circular

Tube: steel, fits 1" diameter bore.

To order without trim: 82TD5 and finish

8TD3B Deadbolt Tube Assembly

Bolt throw: 1"

Backset: 2-3/4"

Faceplate: brass or bronze, 1-1/8" x 2-1/4", self-adjusting and reversible for either door hand.

Tube: steel, fits 1" diameter bore.

To order without trim: 83TDB and finish

8TD35 Drive-in Bolt Tube Assembly

Bolt throw: 1"

Backset: 2-3/4"

Faceplate: brass or bronze, circular.

Tube: steel, fits 1" diameter bore.

To order without trim: 83TD5 and 626 finish

How To Order

8T3	7	K	STK	606	
Backset	Core Housing	Function Code	Strike	Standard Finishes	Options
7T2- 2-3/8" 7T3- 2-3/4" 8T2- 2-3/8" 8T3- 2-3/4"	7- 7 pin housing accepts all BEST cores	see above	STK- standard deadbolt 8T2/8T3 only S1- high security S4- curved lip S5- high security deadbolt (630 finish only)	72T/73T: 612 626 8T2/8T3: 605 606 611 612 613 625 626 690	CS - concealed screws (8T2/8T3 only) D5 - drive-in bolt (8T2/8T3 only) LL - lead lined (83T only) NF- narrow face 1" (std. 8T2) SH- security head screws (8T2/8T3 only) WF- wide face 1 1/8" (std. 8T3) Door thickness - specify if other than 1 3/4" 8T2/8T3 only)

**Must specify key mark and number of keys or designate L/C for less core.

Service Equipment

KD304A Boring Jig Kit

The KD304A jig kit is made for boring cut-outs in wooden doors for Fed. Spec. 160 and 161 series cylindrical/tubular locksets, doors 1-3/8" to 2-1/4" thick. The KD304A kit includes the boring jig (to drill wood doors for 2-3/8", 2-3/4", 3-3/4", and 5" backsets), a quick-release adaptor for 3/8" drill chuck, a 2-1/8" bit, and a 1" diameter x 9" bit.

The following kit items can also be purchased separately.

KD309 – 2-1/8" bit

KD318 – 1" dia. x 9" bit

KD319 – 3/8", quick release adaptor

To order complete kits specify: KD304A Kit

KD312 and KD315 Face Plate Marking Chisel and KD325 Strike Plate Location Pin The KD315 face plate marking chisel (which locates the mortising for the faceplate) and the KD325 strike locating pin (which centers the strike for proper installation) and is used for Fed. Spec. 161 cylindrical lockset, (1-1/8" x 2-1/8"), and BEST® series 82T & 83T tubular locks. The KD312 face plate marking chisel is available for Fed. Spec. 160 (1" x 2-1/4") preparation.

To order specify: KD312– face plate marking chisel 1" (160)

KD315– face plate marking chisel 1-1/8" (161)

KD325– strike plate locating pin



KD304A parts



KD304A with case



KD315 (Fed. Spec. 161)



KD325

CORMAX™ Patented Keying System

BEST® CORMAX™ is the premier patented keying system offered by BEST. CORMAX will meet your needs for security, key control, and convenience. A simple solution with no compromising allowed. CORMAX is the upgrade path for existing BEST Standard, Premium, and MX8 customers; and it is an essential element of non-residential access control as security administrators strive to eliminate the unauthorized duplication of keys.

CORMAX offers the following features and benefits:

- A long-term US utility patent that guarantees the extended useful life of the system through 2027.
- A second, independent locking mechanism that utilizes a patented set of built-in side pins to provide higher security.
- Several levels of geographical exclusivity, including national exclusivity, are available via the patented side pin feature.
- CORMAX cores and keys are available exclusively through BEST sales offices. Key blanks are only sold to individuals authorized by the customer to ensure key blanks do not end up in the possession of unauthorized personnel either inside or outside the customer's facility.
- CORMAX cores are certified to meet the security, safety, and reliability requirements of BHMA A156.5 Grade 1.
- Picking and drilling resistance options are available if higher levels of security are desired.
- Complete factory masterkeying service offered, and at no charge with purchase of BEST locksets and PHI exit devices.
- Keyways are organized in families of four keyways each, with double-milled and quad-milled key levels to facilitate the design of masterkey systems in multi-building campuses.
- BEST CORMAX cores are compatible with all existing BEST interchangeable core housings, eliminating the need for new or modified locksets.



CORMAX™
Patented Keying System

For questions about ordering and to be sure you get the right configuration for your needs, [contact your BEST dormakaba sales representative](#).
6161 East 75th Street, Indianapolis, IN 46250 USA | [855-365-2407](tel:855-365-2407) | bestaccess.com